



GE APPLIANCES

# DEHUMIDIFIER

**SAFETY INFORMATION .....3**

**OPERATING INSTRUCTIONS**

Controls .....4  
 How the Dehumidifier Operates .....5  
 Automatic Defrost .....5  
 Choosing a Location .....5  
 Removing Collected Water .....6  
 Water Level.....7  
 Bucket Operation.....7

**CARE AND CLEANING**

Grille and Case .....8  
 Water Bucket .....8  
 Air Filter.....8  
 Bucke Filter.....9  
 Storage.....9

**TROUBLESHOOTING TIPS.....10**

**CONSUMER SUPPORT**

Warranty ..... 11  
 Consumer Support.....14

**OWNER'S MANUAL**

APEH70  
APER70

**ENGLISH/ESPAÑOL**

Write the model and serial numbers here:

Model # \_\_\_\_\_

Serial # \_\_\_\_\_

You can find them on a label on the back of the dehumidifier.

## **THANK YOU FOR MAKING GE APPLIANCES A PART OF YOUR HOME.**

---

Whether you grew up with GE Appliances, or this is your first, we're happy to have you in the family.

We take pride in the craftsmanship, innovation and design that goes into every GE Appliances product, and we think you will too. Among other things, registration of your appliance ensures that we can deliver important product information and warranty details when you need them.

Register your GE appliance now online. Helpful websites and phone numbers are available in the Consumer Support section of this Owner's Manual. You may also mail in the pre-printed registration card included in the packing material.



**GE APPLIANCES**

# IMPORTANT SAFETY INFORMATION

## READ ALL INSTRUCTIONS BEFORE USING THE APPLIANCE

### ▲WARNING

For your safety, the information in this manual must be followed to minimize the risk of fire, electric shock or personal injury.

- Use this appliance only for its intended purpose as described in this Owner's Manual.
- This dehumidifier must be properly installed and grounded as described in this manual before it is used.
- Never operate this dehumidifier in an area that is likely to accumulate standing water. If this condition develops, for your safety disconnect the power supply before stepping into the water.
- Never unplug your dehumidifier by pulling on the power cord. Always grip plug firmly and pull straight out from the receptacle.
- Replace immediately all electric service cords that have become frayed or otherwise damaged. A damaged power supply cord must be replaced with a new power supply cord obtained from the manufacturer and not repaired. Do not use a cord that shows cracks or abrasion damage along its length or at either the plug or connector end.
- If the receptacle does not match the plug, the receptacle must be changed out by a qualified electrician
- Turn the dehumidifier OFF and unplug it before cleaning.
- GE Appliances does not support any servicing of the dehumidifier. We strongly recommend that you do not attempt to service the dehumidifier yourself.
- For your safety, do not store or use combustible materials, gasoline or other flammable vapors or liquids in the vicinity of this or any other appliance.
- All dehumidifiers contain refrigerants, which under federal law must be removed prior to product disposal. If you are getting rid of an old product with refrigerants, check with the company handling disposal about what to do.
- Do not use outdoors.
- This dehumidifier is intended for indoor residential applications only. This dehumidifier should not be used for commercial or industrial applications.
- These R410A Dehumidifier Systems require contractors and technicians to use tools, equipment and safety standards approved for use with this refrigerant. DO NOT use equipment certified for R22 refrigerant only.

### ▲WARNING

#### USE OF EXTENSION CORDS

**RISK OF FIRE. Could cause serious injury or death.**

- DO NOT use an extension cord with this Dehumidifier.
- DO NOT use surge protectors or multi-outlet adaptors with this Dehumidifier.

#### HOW TO CONNECT ELECTRICITY

Do not, under any circumstances, cut or remove the third (ground) prong from the power cord. For personal safety, this appliance must be properly grounded.

DO NOT use an adapter plug with this appliance.

The power cord of this appliance is equipped with a 3-prong (grounding) plug which mates with a standard 3-prong (grounding) wall outlet to minimize the possibility of electric shock hazard from this appliance.

Have the wall outlet and circuit checked by a qualified electrician to make sure the outlet is properly grounded.

Where a 2-prong wall outlet is encountered, it is your personal responsibility and obligation to have it replaced with a properly grounded 3-prong wall outlet.

The dehumidifier should always be plugged into its own individual electrical outlet, which has a voltage rating matching the rating plate.

This provides the best performance and also prevents overloading house wiring circuits, which could cause a fire hazard from overheated wires.

#### RECYCLING INFORMATION

For appliance recycling information please visit [www.geappliances.com/recycling](http://www.geappliances.com/recycling).

## READ AND SAVE THESE INSTRUCTIONS

# Controls

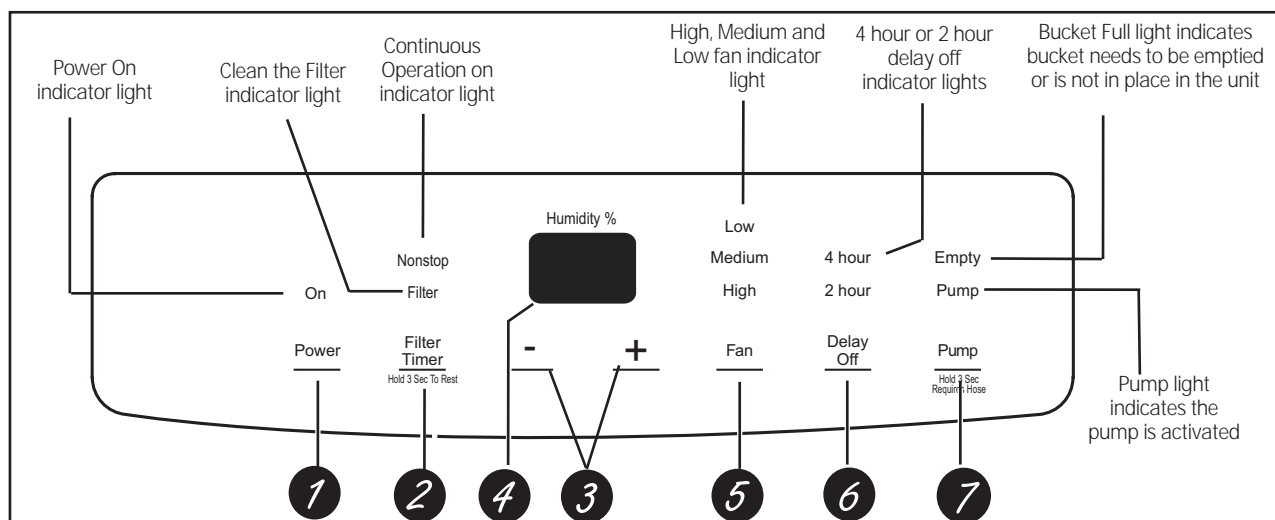

## Controls

**NOTE:** When the bucket is full or removed, the controls cannot be set.

### 1. Power Pad

Press to turn the dehumidifier on and off.

### 2. Filter Timer

After 250 hours of operation, the Clean the Filter indicator light will glow to remind you to clean the filter. Remove the filter and clean it.

Press to turn off the Clean the Filter light. See the Care and Cleaning section.

### 3. Humidity Set Control Pads

The humidity level can be set within a range of 35% RH (Relative Humidity) to 80% RH (Relative Humidity) in 5% increments or at NS for continuous operation. To set the unit for continuous operation, press the ▼ pad until the screen reads NS.

**NOTE:** If NS (Nonstop) is selected, the dehumidifier will operate continuously at its maximum dehumidification settings if attached to a hose to drain or until the bucket is full.

For drier air, press the ▼ pad and set to a lower percent value (%).

For damper air, press the ▲ pad and set to a higher percent value (%).

When you first use the dehumidifier, set the humidity control to 45% or 50%. Allow at least 24 hours for the dehumidifier to achieve the humidity level. If you still have damper air than desired, set the humidity level to a lower setting or select Nonstop for maximum dehumidification.

### 4. Display

Shows the set % humidity level while setting, then shows the actual (+/- 5% accuracy) room % humidity level.

### 5. Fan Speed Pad

Controls the fan speed.

Press to select either High, Medium or Low fan speed.

Set the fan control to High for maximum moisture removal. When the humidity has been reduced and quiet operation is preferred, set the fan control to Medium or Low.

### 6. Delay Off

While the dehumidifier is in operation, press this pad to set it to automatically turn off in 2 hours or 4 hours.

### 7. Pump

Activates the internal pump function. Press for 3 seconds to activate the internal pump for automatic removal of condensate. The internal pump indicator light will remain illuminated after 3 seconds. Press to deactivate the pump.

## Other Features

### Empty Light

Glow when the bucket is ready to be emptied, or when the bucket is removed or not replaced in the proper position.

### Alarm

If the bucket is full or missing for more than 3 minutes, an alarm will sound for about 10 seconds to remind you to empty and replace the bucket.

### Auto Shut Off

The Water Level Control Switch shuts off the dehumidifier when the bucket is full, or when the bucket is removed

or not replaced in the proper position. **NOTE:** Fan will continue to run approximately 3 minutes after bucket is removed.

### Auto Defrost

When frost builds up on the evaporator coils, the compressor will cycle off and the fan will continue to run until the frost disappears.

### Power Outage

In the case of a power outage or interruption, the unit will automatically restart, in the settings last used, after the power is restored.

# Using the Dehumidifier

When first using the dehumidifier, operate the unit continuously for 24 hours.

## How the Dehumidifier Operates

Moist, humid air is drawn over a cold refrigerated dehumidifying coil. Moisture in the air condenses on this coil and drains into a bucket (or through a hose and drain).

Dry, clean air is drawn through the condenser where it is heated and discharged out the top grille into the room.

It is normal for the surrounding air to become slightly warmer as the dehumidifier operates.

## Automatic Defrost

When frost builds up on the evaporator coils, the compressor will cycle off and the fan will continue to run until the frost disappears.

When the coil is defrosted, the compressor or fan will automatically restart and dehumidifying will resume.

## Choosing a Location

A dehumidifier operating in a basement will have little or no effect in drying an adjacent enclosed storage area, such as a closet, unless there is adequate circulation of air in and out of the area.

- **Do not use outdoors.**
- This dehumidifier is intended for indoor residential applications only. This dehumidifier should not be used for commercial or industrial applications.
- Place the dehumidifier on a smooth, level floor strong enough to support the unit with a full bucket of water.
- Allow at least 12–18 inches of air space on all sides of the unit for good air circulation.
- Place the dehumidifier in an area where the temperature will not fall below 41°F (5°C). The coils can become covered with frost at temperatures below 41°F, which may reduce performance.
- Use the dehumidifier in cooking, laundry, bathing and dishwashing areas that have excessive moisture.  
**NOTE:** Place the dehumidifier away from the clothes dryer.
- Use the dehumidifier to prevent moisture damage anywhere books or valuables are stored.
- Use the dehumidifier in a basement to help prevent moisture damage.
- The dehumidifier must be operated in an enclosed area to be most effective.
- Close all doors, windows and other outside openings to the room.

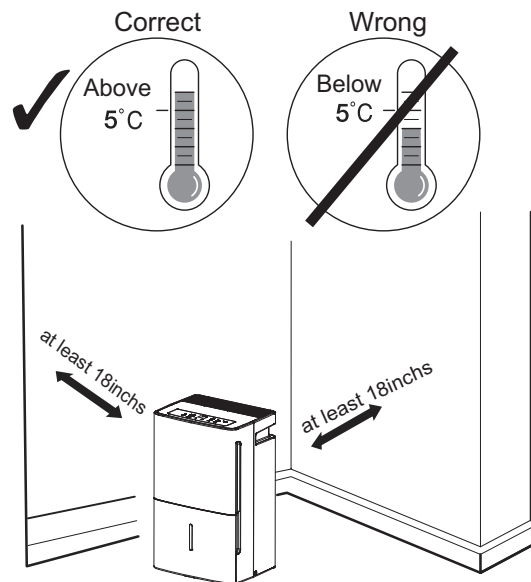

**NOTE:** The dehumidifier has rollers to aid placement, but it should only be rolled on smooth, flat surfaces. Do not attempt to roll the dehumidifier on carpet or over objects.

# Using the Dehumidifier

Always make sure the water bucket is locked into place on the dehumidifier.

## Removing Collected Water

There are 3 ways to remove collected water:

**Use the bucket.** When the bucket is removed, the unit will shut off. Empty and replace the bucket.

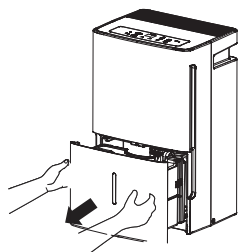

**IMPORTANT:** Do not use the hose if using the bucket to collect water. When the hose is connected, water will flow through it onto the floor instead of into the bucket.

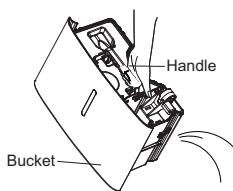

**NOTES:**

- Do not remove the bucket while the dehumidifier is operating or if it has just stopped operating. This might cause some water to drip from the drain pan.
- The bucket must be in place and securely seated for the dehumidifier to operate.

**Use a hose.** Water can be automatically emptied into a floor drain by attaching a garden water hose (not included).

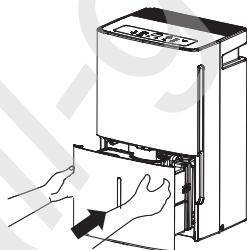

1. Remove the bucket from the front of the unit.
2. Open the drain cover on the back of the unit.

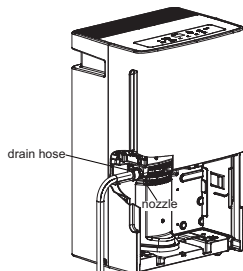

3. Thread a garden hose (not supplied) onto the nozzle, cut to length, and lead it to the floor drain.

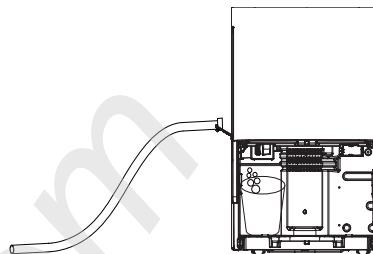

4. Replace the bucket in the unit.

**NOTE:** The bucket must be in place and securely seated for the dehumidifier to operate.

**Use the internal pump.** Water can be automatically emptied into a remote location by attaching the included pump hose.

1. Attach the pump hose to the hose connector by pushing the tube fitting into the connector until it fits into place (should not be able to remove the hose when pulled).
2. Position the hose discharge to the desired location.
3. Make sure the pump is activated. To activate the pump, press and hold the Pump button for 3 seconds. The Pump indicator light will flash then remain illuminated once the 3 seconds are complete.

**IMPORTANT:** Make sure the condensate hose is properly connected and is not kinked, bent or cracked as this may cause water to flow onto the floor. The bucket must also be fully seated for the pump to work properly. Do not operate the machine if the room temperature is 32°F or below.

**NOTES:**

- Maximum lift height is 16ft.
- The bucket must be in place and securely seated for the dehumidifier and pump to operate. Make sure to install hose (included) before activating the pump.

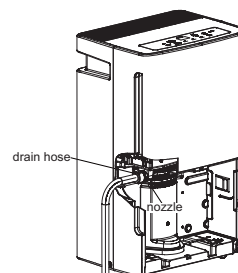

# Using the Dehumidifier

## Removing Collected Water (Continued)

**To Install Hose:** Push in hose and gently pull to make sure it is secure.

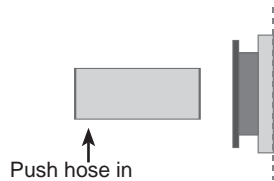

**NOTE:** DO NOT kink or crimp hose, as it can block water flow.

**To Release Hose:** Hold the grey ring while pulling to remove.

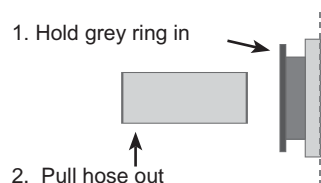

## Water Level

The dehumidifier will turn off automatically when the bucket is full, or when the bucket is removed or not replaced in the proper position.

The bucket must be replaced in the proper position for the dehumidifier to work. The light will be on and the dehumidifier will not run if the bucket is not in the proper position.

## Bucket Operation

DO NOT remove the foam piece in the bucket assembly. If removed the Dehumidifier will not work properly.

When the coil is defrosted, the compressor or fan will automatically restart and dehumidifying will resume.

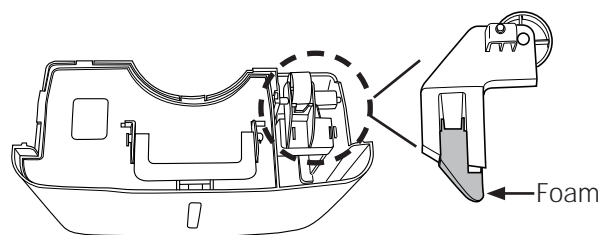

# Care and Cleaning

Turn off the dehumidifier and remove the plug from the wall outlet before cleaning.

## Grille and Case

### To clean the case:

Use water and a mild detergent. Do not use bleach or abrasives.

### To clean the front grille:

Use a vacuum attachment or brush.

## Water Bucket

### To clean:

Every few weeks, clean the bucket to prevent growth of mold, mildew and bacteria. Partially fill the bucket with clean water and add a little mild detergent. Swish it around in the bucket, empty and rinse.

**NOTE:** Do not use a dishwasher to clean the water bucket.

### To remove:

Remove the bucket and pour out any water.

### To replace:

Slide the bucket into the dehumidifier.

**NOTE:** The bucket must be in place and securely seated for the dehumidifier to operate.

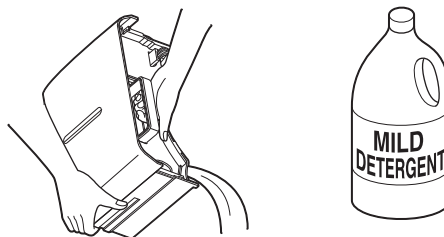

## Air Filter

The air filter behind the front grille should be checked and cleaned at least every 250 hours of operation or more often if necessary.

After 250 hours of operation, the Clean the Filter indicator light will glow to remind you to clean the filter. Remove the filter and clean it. Replace the filter and press the Filter Timer pad to turn off the Clean the Filter light.

### To remove:

Remove the bucket. Grasp the filter edge, and pull it straight down and out.

### To clean:

Clean the filter with warm, soapy water. Rinse and let the filter dry before replacing it.

**NOTE:** DO NOT rinse or put the filter in an automatic dishwasher.

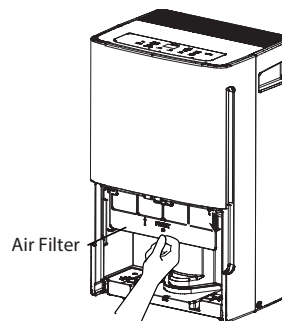

**NOTE:** Avoid using a dishwasher to clean the filter.



**DO NOT** operate the dehumidifier without a filter because dirt and lint will clog it and reduce performance.



# Care and Cleaning

## Bucket Filter

The bucket filter is located inside the bucket near the bottom. The filter should be checked when cleaning the bucket. If the filter has any debris on it, gently remove the filter as described below and rinse with warm water. Replace the filter in the bucket once it is clean.

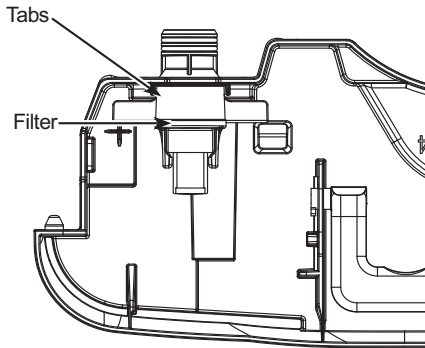

**IMPORTANT:** Be careful not to tear or damage filter during removal, cleaning or replacement. Do not use the dishwasher to clean the filter.

### TO REMOVE THE FILTER:

1. Lift the handle to make the ends of the handle align with the holes in the clasps. Push the handle towards one of the clasps keeping the handle aligned with the clasp slots. Push the other clasp away from the handle allowing the handle to be separated from the clasp. Remove the handle from the other clasp.

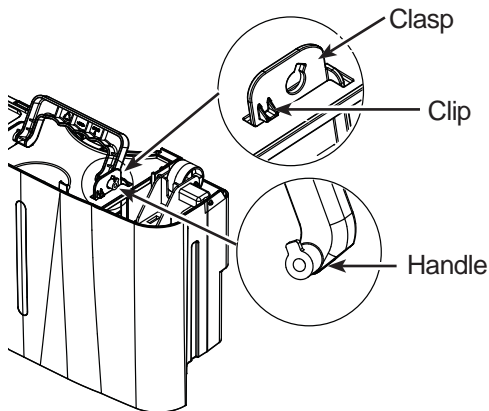

2. Squeeze both clasp inward to disengage clasp clips from water tank cover. Lift the cover upwards to remove.

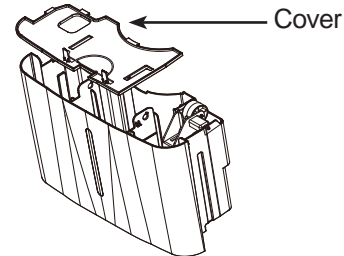

3. Lift the end of the filter upwards to remove the filter.

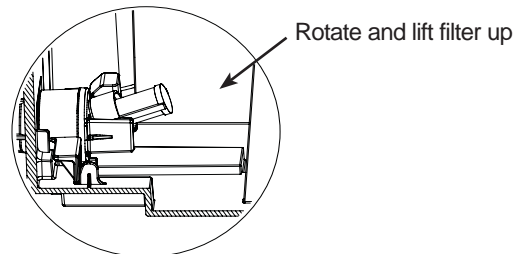

### TO REPLACE THE FILTER:

4. Place large end of filter above tabs, press filter down firmly to spread tabs. Once filter is between tabs press filter inward to engage tabs into filter.
5. Replace water tank cover and handle.

## Storage

If the unit is to be stored for an extended period of time, take the following actions before putting away the machine.

1. Empty the bucket of all water.
2. Clean the water bucket and bucket filter per instructions.
3. Allow water bucket to dry and reinstall.
4. Remove pump hose and store with unit.

**To Release Hose:** Hold the grey ring while pulling the hose to remove.

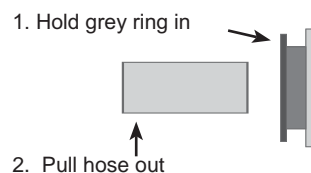

## Troubleshooting Tips... Before you call for service

Save time and money! Review the charts on the following pages first and you may not need to call for service.

Problem	Possible Cause	What To Do
Dehumidifier does not start	The dehumidifier is unplugged.	Makes sure the dehumidifier's plug is pushed completely into the outlet.
	The fuse is blown/circuit breaker is tripped.	Check the house fuse/circuit breaker box and replace the fuse or reset the breaker.
	Dehumidifier has reached its preset level or bucket is full.	The dehumidifier automatically turns off when either condition occurs. Change to a lower setting or empty the bucket and replace properly.
	Bucket is not in the proper position.	The bucket must be in place and securely seated for the dehumidifier to operate.
	Power Failure.	There is a protective time delay (up to 3 minutes) to prevent tripping of the compressor overload. For this reason, the unit may not start normal heating or cooling for 3 minutes after it turned back on.
Dehumidifier does not dry the air as it should	Did not allow enough time to remove the moisture.	When first installed, allow at least 24 hours to maintain the desired dryness.
	Airflow is restricted.	Make sure there are no curtains, blinds or furniture blocking the front or back of the dehumidifier. See the <i>Choosing a Location</i> section.
	Dirty Filter	See the <i>Care and Cleaning</i> section.
	The Humidity Control may not be set low enough.	For drier air, press the + pad and set to a lower percent value (%) or at NS (Nonstop) for maximum dehumidification.
	Doors and windows may not be closed tightly.	Check that all doors, windows and other openings are securely closed.
	Clothes dryer may be blowing moisture-laden air into the room.	Install the dehumidifier away from the dryer. The dryer should be vented to the outside.
	Room temperature is too low.	Moisture removal is best at higher room temperatures. Lower room temperatures will reduce the moisture removal rate. Models are designed to be operated at temperatures above 41°F (5°C).
Dehumidifier runs too much	Area to be dehumidified is too large.	The capacity of your dehumidifier may not be adequate.
	Doors and windows are open.	Close all doors and windows to the outside.
Frost appears on the coils	Dehumidifier has been turned on recently, or room temperature is below 41°F (5°C)	This is normal. Frost will usually disappear within 60 minutes. See the Automatic Defrost section
Control cannot be set	The compressor will turn off and the fan will automatically continue to run for approximately 3 minutes at a fixed setting.	This is normal. Wait approximately 3 minutes and set the fan as desired.
Fan noise	Air is moving through the dehumidifier.	This is normal.
Water on floor	Hose connection may be loose.	Check the hose connection. See the <i>Removing Collected Water</i> section.
	Intended to use the bucket to collect water, but a hose was attached.	Disconnect the hose if using a bucket to collect water. See the <i>Removing Collected Water</i> section.
Bucket Full LED light flashing and alarm sounds while drain hose is connected.	Drain hose not tight on fitting.	Check drain hose connection.
	Drain hose is kinked.	Ensure the drain hose is pointed straight down to the floor and is not kinked in anyway.

# GE Appliances Dehumidifier - One-Year Limited Warranty

For customers in the U.S.A.

**WARRANTY**

<b>For The Period Of:</b>	<b>GE Appliances Will Replace:</b>
<b>One Year</b> From the date of the original purchase	<b>Replacement unit</b> for any product which fails due to a defect in materials or workmanship. The replacement unit is warranted for the remainder of your product's original one-year warranty period.

## In Order to Make a Warranty Claim:

- Properly pack your unit. We recommend using the original carton and packing materials.
- Return the product to the retail location where it was purchased.
- Include in the package a copy of the sales receipt or other evidence of date of original purchase. Also print your name and address and a description of the defect.

## What GE Appliances Will Not Cover:

- Customer instruction. This owner's manual provides information regarding operating instructions and user controls.
- Improper installation, delivery or maintenance. If you have an installation problem, or if the dehumidifier is of improper dehumidification capacity, contact your dealer or installer. You are responsible for providing adequate electrical, plumbing and other connecting facilities.
- Failure of the product resulting from modifications to the product or due to unreasonable use including failure to provide reasonable and necessary maintenance.
- Replacement of house fuses or resetting of circuit breakers.
- Failure due to corrosion on models not corrosion-protected.
- Damage to the product caused by improper power supply voltage, accident, fire, floods or acts of God.
- Incidental or consequential damage caused by possible defects with this air conditioner.
- Damage caused after delivery.

**EXCLUSION OF IMPLIED WARRANTIES**—Your sole and exclusive remedy is product repair as provided in this Limited Warranty. Any implied warranties, including the implied warranties of merchantability or fitness for a particular purpose, are limited to one year or the shortest period allowed by law.

This warranty is extended to the original purchaser and any succeeding owner for products purchased for home use within the USA.

Some states do not allow the exclusion or limitation of incidental or consequential damages. This warranty gives you specific legal rights, and you may also have other rights which vary from state to state. To know what your legal rights are, consult your local or state consumer affairs office or your state's Attorney General.

Exclusion of implied warranties: Except where prohibited or restricted by law, there are no warranties, whether express, oral or statutory which extend beyond the description on the face hereof, including specifically the implied warranties of merchantability or fitness for a particular purpose.

**Warrantor: GE Appliances**

Staple your receipt here. Proof of the original purchase date is needed to obtain service under the warranty.

**WARRANTY**

# GE Appliances Dehumidifier - One-Year Limited Warranty

For customers in the Canada

<b>For The Period Of:</b>	<b>GE Appliances Will Replace:</b>
One Year From the date of the original purchase	Replacement unit for any product which fails due to a defect in materials or workmanship. The replacement unit is warranted for the remainder of your product's original one-year warranty period.

## In Order to Make a Warranty Claim:

- Properly pack your unit. We recommend using the original carton and packing materials.
- Return the product to the retail location where it was purchased.
- Include in the package a copy of the sales receipt or other evidence of date of original purchase. Also print your name and address and a description of the defect.

## What GE Appliances Will Not Cover:

- Customer instruction. This owner's manual provides information regarding operating instructions and user controls.
- Improper installation, delivery or maintenance. If you have an installation problem, or if the dehumidifier is of improper dehumidification capacity, contact your dealer or installer. You are responsible for providing adequate electrical, plumbing and other connecting facilities.
- Failure of the product resulting from modifications to the product or due to unreasonable use including failure to provide reasonable and necessary maintenance.
- Replacement of house fuses or resetting of circuit breakers.
- Failure due to corrosion on models not corrosion-protected.
- Damage to the product caused by improper power supply voltage, accident, fire, floods or acts of God.
- Incidental or consequential damage caused by possible defects with this air conditioner.
- Damage caused after delivery.

**EXCLUSION OF IMPLIED WARRANTIES**—Your sole and exclusive remedy is product repair as provided in this Limited Warranty. Any implied warranties, including the implied warranties of merchantability or fitness for a particular purpose, are limited to one year or the shortest period allowed by law.

Staple your receipt here. Proof of the original purchase date is needed to obtain service under the warranty.

This warranty is extended to the original purchaser and any succeeding owner for products purchased in Canada for home use within Canada.

Some provinces do not allow the exclusion or limitation of incidental or consequential damages, so the above exclusion may not apply to you. This warranty gives you specific legal rights, and you may also have other rights which vary from province to province. To know what your legal rights are in your province, consult your local or provincial consumer affairs office.

Exclusion of implied warranties: Except where prohibited or restricted by law, there are no warranties, whether express, oral or statutory which extend beyond the description on the face hereof, including specifically the implied warranties of merchantability or fitness for a particular purpose.

**Warrantor: MC Commercial  
Burlington, Ontario**

# Notes

---

# Consumer Support

---

## GE Appliances Website

Have a question or need assistance with your appliance? Try the GE Appliances Website 24 hours a day, any day of the year! You can also shop for more great GE Appliances products and take advantage of all our on-line support services designed for your convenience. In the US: [GEAppliances.com](http://GEAppliances.com)

---

## Register Your Appliance

Register your new appliance on-line at your convenience! Timely product registration will allow for enhanced communication and prompt service under the terms of your warranty, should the need arise. You may also mail in the pre-printed registration card included in the packing material. In the US: [GEAppliances.com/register](http://GEAppliances.com/register)

---

## Schedule Service

Expert GE Appliances repair service is only one step away from your door. Get on-line and schedule your service at your convenience any day of the year. In the US: [GEAppliances.com/ge/service-and-support/service.htm](http://GEAppliances.com/ge/service-and-support/service.htm) or call 800.432.2737 during normal business hours.

---

## Extended Warranties

Purchase a GE Appliances extended warranty and learn about special discounts that are available while your warranty is still in effect. You can purchase it on-line anytime. GE Appliances Services will still be there after your warranty expires. In the US: [GEAppliances.com/ge/service-and-support/shop-for-extended-service-plans.htm](http://GEAppliances.com/ge/service-and-support/shop-for-extended-service-plans.htm) or call 800.626.2224 during normal business hours.

---

## Remote Connectivity

For assistance with wireless network connectivity (for models with remote enable), visit our website at [GEAppliances.com/ge/connected-appliances/](http://GEAppliances.com/ge/connected-appliances/) or call 800.220.6899 in the US.

---

## Parts and Accessories

Individuals qualified to service their own appliances can have parts or accessories sent directly to their homes (VISA, MasterCard and Discover cards are accepted). Order on-line today 24 hours every day. In the US: [GEApplianceparts.com](http://GEApplianceparts.com) or by phone at 877.959.8688 during normal business hours.

**Instructions contained in this manual cover procedures to be performed by any user. Other servicing generally should be referred to qualified service personnel. Caution must be exercised, since improper servicing may cause unsafe operation.**

---

## Contact Us

If you are not satisfied with the service you receive from GE Appliances, contact us on our Website with all the details including your phone number, or write to:

In the US: General Manager, Customer Relations | GE Appliances, Appliance Park | Louisville, KY 40225  
[GEAppliances.com/ge/service-and-support/contact.htm](http://GEAppliances.com/ge/service-and-support/contact.htm)