



---

## DDX Series

### DEHUMIDIFIER

Instructions for use. Keep these instructions

Visit [www.delonghi.com](http://www.delonghi.com) for a list  
of service centers near you.

ELECTRIC CHARACTERISTICS

120 V~ 60 Hz

### DÉSHUMIDIFICATEUR

Mode d'emploi . Conservez cette notice

Visitez [www.delonghi.com](http://www.delonghi.com) pour y voir une liste des  
centres de réparation proches de chez vous.

CARACTÉRISTIQUES ÉLECTRIQUES

120 V~ 60 Hz

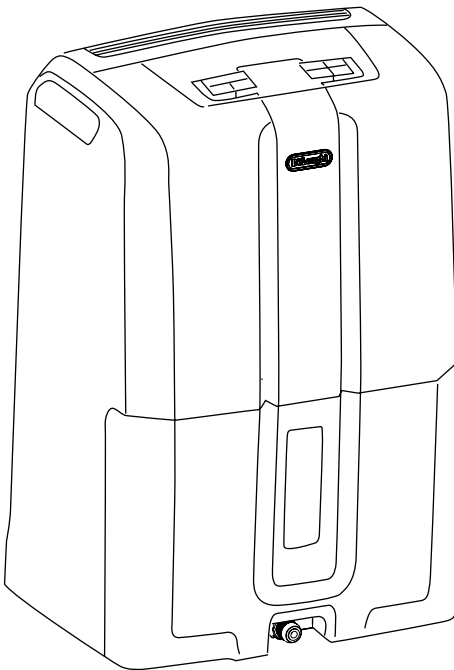

### DESHUMIDIFICADOR

Repase y guarde estas instrucciones.

Lea cuidadosamente este instructivo  
antes de usar su aparato.

Visite [www.delonghi.com](http://www.delonghi.com) para ver la lista de centros de  
servicios cercanos a usted.

CARACTERISTICAS ELECTRICAS:

120 V~ 60 Hz

---

The DeLonghi logo, consisting of the brand name "DeLonghi" in a bold, sans-serif font, enclosed within a rounded rectangular border.

## SOME NOTIONS ON HUMIDITY

Air always contains a certain amount of water in the form of vapour. This determines the level of humidity in an atmosphere.

The capacity of the air to hold water vapour increases with temperature.

This is why in our homes, as soon as the temperature decreases, the vapour contained in the air condenses, as is evident on the colder surfaces in the room, such as the windows, walls etc.

The purpose of a dehumidifier is to remove the excess moisture from the air, avoiding the damage caused by condensation.

Experts have established that the optimum environmental conditions for our well being and for the home are obtained between 40% and 60% relative humidity. Lower relative humidity can be achieved with higher room temperatures. For lower room temperatures the achievable relative humidity will be on the higher side, closer to 60%. Therefore, with lower room temperatures, you are recommended to heat the room even minimally.

This considerably increases the dehumidifying power of the appliance.

With heating, the condensation formed by the water vapour on windows and other cold surfaces evaporates into the air to be collected by the dehumidifier.

## DESCRIPTION/ACCESSORIES

1. Control panel
2. Water level viewing window
3. Condensate collection tank
4. Handles
5. Air intake grille
6. Dust filter
7. Air outlet grille
8. Drain hose to be used at the back of the unit
9. Pump tube to be used at the front of the unit
10. Connector for PUMP draining (first remove stopper; only on pump models)
11. Wheels

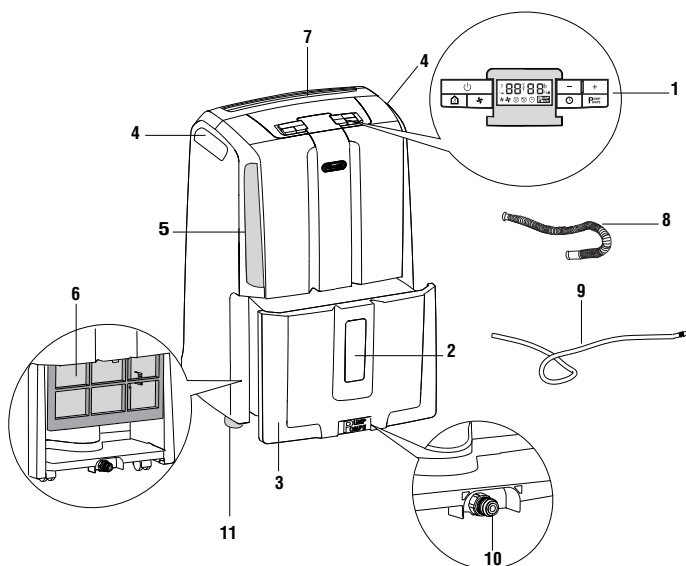

## INTRODUCTION

Thank you for choosing a De'Longhi product. Take a couple of minutes to read these instructions. This will avoid danger or damage to the appliance.

### Symbols used in these instructions

These symbols draw your attention to important warnings.

It is vital to respect these warnings.

Failure to do so may result in electric shock, serious injury, burns, fire or damage to the appliance.



#### **Danger!**

Failure to observe this warning may result in life threatening injury by electric shock.



#### **Important!**

Failure to observe this warning may result in injury or damage to the appliance.



#### **Note!**

This symbol draws your attention to important recommendations and informatio

### Problems and repairs

In the event of problems, first try and resolve them by reading the information given in the "Troubleshooting" section on page 9.

If the appliance requires repair, always contact a Center authorized by the manufacturer.

Always insist on original spare parts. Repairs carried out by unauthorized personnel may be dangerous and invalidate the guarantee.

## IMPORTANT SAFEGUARDS

### Fundamental safety warnings



**Danger!** This is an electrical appliance, it is therefore important to respect the following safety warnings:

- Do not touch the appliance with wet hands.
- Do not touch the plug with wet hands.
- Make sure the outlet used is always accessible, enabling you to unplug the appliance when necessary.
- Always unplug the appliance using the plug itself. Never pull the cable as it might be damaged.
- To disconnect the appliance completely from the electricity supply, you must unplug it from the outlet.
- If the appliance malfunctions, do not attempt to repair it yourself. Turn the appliance off, unplug from the outlet socket and contact a Service Center.
- Do not move the appliance by pulling the power cable.
- It is dangerous to modify or alter the characteristics of the appliance in any way.
- If the power cable is damaged, it must be replaced by the manufacturer or an authorized technical service center in order to avoid all risk.
- Do not use extension cords.
- The appliance must be installed in accordance with the rules on household appliances in force in the country concerned.
- This appliance is not intended for use for water damage restoration of commercial/household properties.
- The appliance must be connected to a properly grounded outlet. Have your electrical circuit checked by a qualified electrician.



**Danger!** Keep packaging materials (plastic bags, polystyrene foam) out of reach of children.



**Danger!** The appliance is not intended for use by persons (including children) with reduced physical, sensory or mental capabilities, or lack of experience and knowledge, unless they have been given supervision or instruction concerning use of the appliance by a person responsible for their safety. Always supervise children. Make sure they do not play with the appliance.

# SAVE THESE INSTRUCTIONS

## THIS PRODUCT IS FOR HOUSEHOLD ONLY

### Appropriate use

The appliance is designed and produced for domestic use only.

Use this appliance only as described in this instruction manual.

As with all electrical equipment, the instructions aim to cover as many eventualities as possible.

However, caution and common sense should be applied when operating and installing this appliance.

### General safeguards

- Do not install the appliance in rooms containing gas, oil or sulphur. Do not install near sources of heat.
- Do not use the appliance on sloping surfaces.
- Keep the appliance at least 2 ft (61cm) away from flammable substances (alcohol etc) or pressurised containers (e.g. aerosol cans).
- Do not rest heavy or hot objects on top of the appliance.
- Always transport the appliance upright, NOT on its side.

Remember to drain the condensate tank before moving the appliance.

If the appliance was transported on its side, you must wait at least 6 hours before using it (24 hrs is recommended).

**ENVIRONMENTAL INFORMATION:** This unit contains fluorinated greenhouse gases covered by the Kyoto Protocol. Avoid perforating the refrigerant circuit of the appliance.

Maintenance and disposal must be carried out by qualified personnel only (R410A, GWP=2088); (R134a, GWP=1430).

- R410A and R134a are refrigerant gases that complies with EC environmental regulations, nevertheless avoid perforating the refrigerant circuit of the appliance.

At the end of its service life, the air conditioner must be disposed of at a suitable collection centre.

- The materials used for packaging can be recycled. You are therefore recommended to dispose of them in special differentiated waste collection containers.
- Do not use the appliance outdoors.

- When using the appliance to dry laundry, do not place it under dripping clothes or where the unit would come in any contact with water.

### Instructions

Read these instructions carefully before installing and/or using the appliance.

- Keep these instructions.  
If the appliance is transferred to other owners, they should also be given these instructions.
- Failure to respect the instructions may result in injury or damage to the appliance.  
The manufacturer is not liable for damage deriving from failure to follow these instructions.

### Electrical connections

Before plugging the appliance into the outlet, check that:

- The outlet, power supply corresponds to the working voltage indicated on the rating plate.
- The power outlet, and electrical circuit are adequate for the appliance.
- The power outlet, matches the plug. If this is not the case, have the plug replaced by a qualified electrician;
- The outlet is properly grounded.

## INSTALLATION

Position the appliance in the room to be dehumidified. A free space of at least 2 ft (61 cm) must be left at the front of the dehumidifier, so as not to block the air outlet.

For efficient ventilation a space of about 2-4 in (5-10 cm) should be left at the back of the appliance. The condensate can be drained in one of the following ways:

### A) Draining into the tank

The condensate can be drained directly into the tank. The tank can be easily removed (fig.1). When the tank is full, remove (fig.1) and empty it into a sink. When finished, replace it properly.

**NOTE:** The tank must be positioned properly for the unit to function.

If you hear the intermittent sound of the beep, it means the tank is not in the proper position.

### B) Continuous external draining

If the appliance is to be operated for long periods but you are unable to empty the tank regularly, you are recommended to use continuous draining.

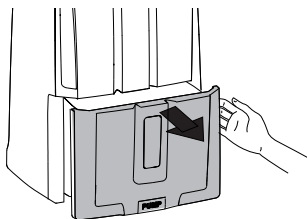

fig. 1

- 1) Remove the continuous drain cap **1** by turning it counterclockwise then remove the rubber stopper **2** from the spout (fig. 2).

**Note:** Some leakages from the spout could happen when removing the rubber stopper **2** (fig. 2).

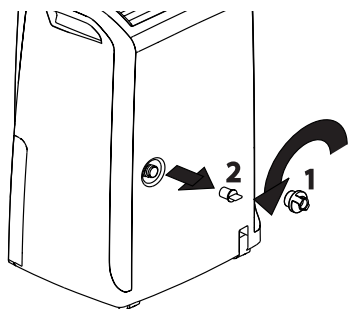

fig. 2

- 2) Insert the drain cap **1** in the condensate drain hose (8) till the end (fig. 3) then screw the cap into the spout. (fig. 4).

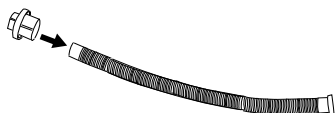

fig. 3

- 3) Make sure the end of the hose is no higher than the spout (Fig. 3) or water could remain in the tank. Make sure there are no kinks in the hose (Fig. 5).

**i** Keep the rubber stopper to close the spout.

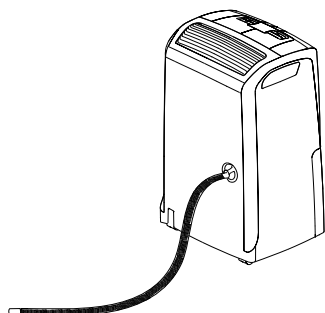

fig. 4

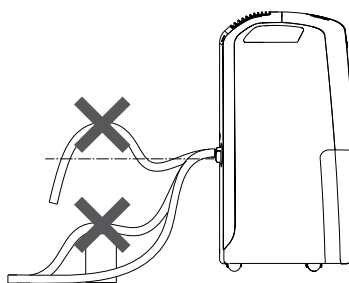

fig. 5

### C) Continuous draining using the pump (only on pump models)

The patented heavy-duty pump system allows water removal of up to 13 ft (4m) in height. If you want the water to flow directly to a drain, connect the condensation discharge tube supplied (9) to the connection pipe located on the lower front part of the unit (you will first need to remove the stopper labeled PUMP) (fig. 6). Select the dehumidifying function and press the PUMP button.

**Note:** With the condensation discharge hose missing and the pump switched ON, the display will show the symbol PUMP blinking.

To eliminate this problem:

- Check the hose is correctly positioned;
- Disconnect and reconnect the plug.

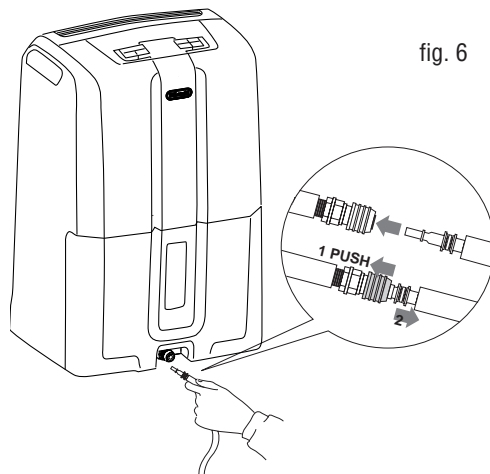
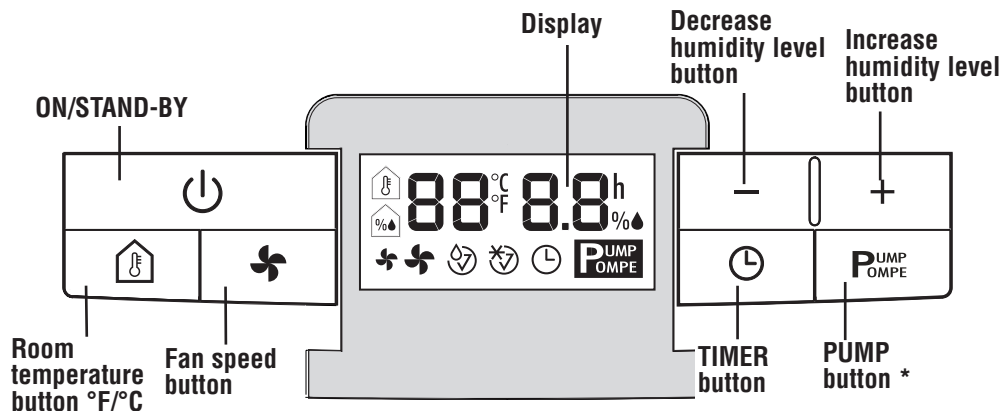

fig. 6

## CONTROL PANEL



\* (only on some models)

### Description of buttons

**1 ON/Standby" button**   
ON/Standby" button

**2 "Fan" button**   
Press this button to select the Fan Speed (MIN or MAX).

**3 Thermometer button**   
Temporarily displays the temperature measured in the room by the appliance. If you press the button once you will see the room temperature in F for a few seconds, then in C for a few seconds, then the display will return to the current level of humidity in the room. If you press the button multiple times, it will cycle through these displays faster. Note: Temperatures displayed are indicative only.

**4 Humidity increase/decrease buttons** — +  
These buttons are used to adjust the desired humidity level, with 5% increments; they are also used to set the timer. From 0 -10 the hours increase by 30 min. and from 10-24 the hours increase by 1 hour increments.

**5 Pump button**   
**(only in some models)**  
When you press the "Pump button" the display will show "PUMP/POMPE". If the display shows "PUMP/POMPE" blinking, it means that the pump is not operating correctly.

**6 Timer button**  
If you press the TIMER button the display will show the hours after which you want the appliance to switch OFF or ON. Once the timer is set the user can no longer adjust the %RH (Relative Humidity)

**Display**  
Meaning of the codes or symbols which may be displayed:

--- Indicates that the appliance is in standby mode.

 **Tank warning symbol**  
If the water tank is full, improperly positioned or missing, the tank warning light will start blinking. An alarm will sound until the tank is either emptied or correctly positioned into place.

 **Defrosting indicator symbol**  
With an ambient temperature of less than 59°F (15°C) the appliance performs defrosting cycles. While the appliance is defrosting, the defrosting symbol comes on and remains on until defrosting is completed. This symbol will also be displayed if the unit is switched on immediately after being turned off. The unit requires 3 minutes before it can function again.

## MODE SELECTION

- 1) Plug the appliance into a an outlet.
- 2) the display will show "-- --" to indicate that the appliance is in stand-by and ready for use. If the display shows "⌚" it's necessary to empty the tank or the tank is incorrectly positioned
- 3) Press the ON/Stand-by ⏻ button.

### Dehumidifying Mode

The display will show on the left side the room humidity level (ex.: % 63) and on the right side the display will show the degree of humidity you want to reach (ex.: 58 %).

Press the "+" or "-" button to set the desired humidity level (30% means a dry environment,, 80% a humid environment).

Press the "⚙" to select the fan speed (MIN/MAX). If you select MAX, the appliance will operate to the maximum speed. If you select MIN, the appliance will operate to the minimum speed. and the noise levels will be reduced.

Press button "⌚" to display the Temperature on the LCD display. On the left side the display will show first the °F and then the temperature in °C.

After few seconds, the display will automatically show the humidity level.

When the appliance reaches the humidity set point the appliance will automatically stop working but the fan will work at the minimum speed.

As soon as the humidity increases above the set point, the appliance will automatically resume dehumidification operation.

### Continuous Dehumidifying Function

In order to operate the continuous dehumidifying function press button "-" until the display will show "--".

With this function the appliance will operate continuously.

## TIMER

### How to program the delayed start function: From the OFF Position

- 1) With the unit in the stand-by position, press the ⏻ button. On the right side the display will show ⌚ and the number of hours after which the appliance will start operating.
- 2) Use the + and - button to set the desired hours. Wait few seconds to set the set appliance. The symbol ⌚ and the remaining time will remain on the display.
- 3) When the selected time is reached, the appliance will start working.

### How to Program the delayed stop function: From the ON Position

- 1) With the unit in the ON position, press the ⏻ button. On the right side the display will show ⌚ and the number of hours after which the appliance will stop operating.
- 2) Use the + and - button to set the desired hours. Wait few seconds to set the appliance. The symbol ⌚ and the remaining time will remain on the display.
- 3) When the selected time is reached, the appliance will stop working.

### How to modify or deactivate the timer

If you wish to modify the set value, press once the timer button and press then buttons + and -. If you wish to deactivate the timer press the timer button twice.



**Note:** When switching the appliance on or when the electricity is restored, the appliance will start working on the previously selected mode.



## CLEANING AND MAINTENANCE

Always unplug the appliance from the power outlet before performing any cleaning or maintenance operations.

For safety reasons, never wash the dehumidifier using a jet of water.

### Cleaning the cabinet

- Clean the appliance using a damp cloth then dry with a dry cloth.
- Do not use petrol, alcohol or solvents to clean the appliance.
- Do not spray liquid insecticide or similar products as they may deform the plastic.

### Cleaning the air filter or silver-ion air filter

If the filter is dirty, air circulation is compromised and the efficiency of the dehumidifying and air purifying functions decreases.

It is therefore good practice to clean the filter at regular intervals. The frequency depends on the duration and conditions of operation.

If the unit is used constantly or systematically, you are recommended to clean the filter once a week.

To remove the filter, pull it down as shown in figure 7.

Use a vacuum cleaner to remove dust accumulations from the filter. If the filter is very dirty, rinse well with lukewarm water. The temperature of the water should not exceed 40°C. After washing the filter, allow it to dry completely before reinserting it.

If present, the silver-ion air filter, besides retaining powder particles, has also an efficient antibacterial action. In addition, it greatly reduces irritants such as pollen and spores.

The filter is treated with small particles of silver (on the scale of millionths of a millimetre) which are able to block the multiplication of and destroy any bacteria or spores coming into contact with them.

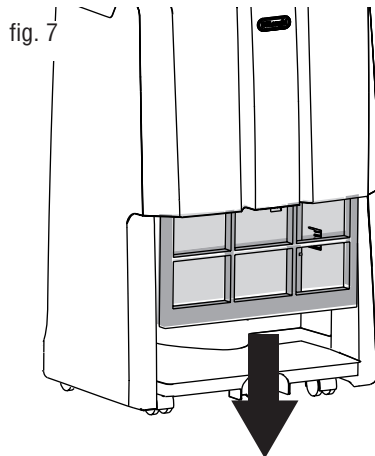

### If the appliance is not used for long periods

- After unplugging the appliance from the power outlet, empty the tank.
- Clean and reposition the filter.
- Cover the appliance with a plastic bag to protect it from dust.



## TECHNICAL SPECIFICATIONS

Power supply voltage	See rating plate
Absorbed power	"
Maximum power input	"
Freeze protection device	Yes
Hygrometer	Yes
Fan speeds	2
Air filter	Yes

Operating limits:	
temperature	41°F - 89.6°F (5°C - 32°C)
relative humidity	30-90%

## TROUBLESHOOTING

Check the following points before calling your local authorised Service Centre.

PROBLEMS	CAUSE	SOLUTION
The appliance is operating in dehumidifying mode, but the humidity does not decrease.	<p>The filter is blocked.</p> <p>The temperature or humidity in the room are too low.</p> <p>The room is too big for the dehumidifying power of the appliance.</p> <p>Too many sources of humidity in the room (pots of boiling water, etc.).</p> <p>The humidity set point is too high.</p>	<p>Clean the filter.</p> <p>In certain conditions, it is normal for the appliance not to dehumidify (in certain cases, it is recommended to heat the environment).</p> <p>Decrease the humidity set point.</p>
The appliance does not work for 3 minutes after start-up.	The safety device has tripped.	Wait for 3 minutes to pass.
 is displayed	<p>The tank is missing.</p> <p>The tank is full.</p> <p>The tank is incorrectly positioned.</p>	<p>Replace the tank.</p> <p>Empty the tank.</p> <p>Position the tank correctly.</p>
 is displayed	The temperature in the room is very low.	Increase room temperature.
"E2"/"E3" is displayed	One of the sensors on the appliance is faulty.	Call the Service Centre.
Symbol "PUMP/POMPE" blinking	The pump tube 9 is missing or clogged or blocked.	Check the hose is correctly positioned or unclogged, To reset the alarm disconnect and reconnect the plug. If the problem persists, call the service centre