

## Some notions on humidity

**A**ir in nature always contains a certain quantity of moisture in form of water vapour, and such quantity determined the humidity level of the air. Nonetheless, the capacity of the air to hold water vapour is quite limited, and depends on the temperature: the higher the temperature, the more water can be held in the air. **Absolute humidity (AH)** indicates the quantity of water vapour contained in 1 kg of air, and is expressed in grams. **Relative humidity (RH)** is the ratio, in percentage terms, between the quantity of moisture contained in 1 kg of air and the maximum quantity that the air can hold at such conditions.

ENGLISH

Experts have established that the best environmental conditions, both for the human organism and the conservation of objects, involves a relative humidity of between 45% and 60%. Consequently, the ambient relative humidity should be maintained within this range. A dehumidifier is an appliance that eliminates any excess moisture present in the air

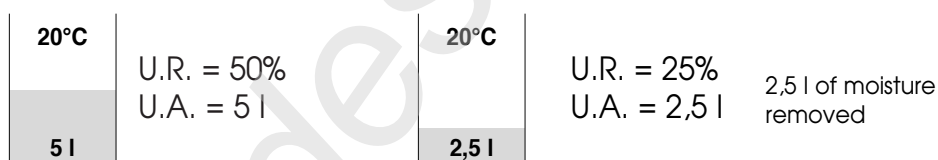

There is also another method used to lower relative humidity, that is, increase the ambient temperature. It is like increasing the capacity of the tank. Therefore, air at 20°C acts like a 10 litre tank, while air at 30°C acts like a 20 litre tank.

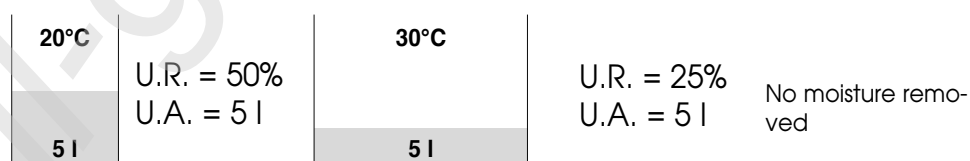

Certainly, increasing the room temperature alone does not provide a solution to the humidity problem. Heating the air simply maintains the same humidity level suspended in the air in the form of water vapour. As soon as the temperature decreases again, this water vapour will start to condense. On the other hand, heating combined with dehumidification (such as in the combined operation of this dehumidifier) is very useful. Especially at low temperatures, or to dry the washing. In fact, the heating function transforms the moisture into water vapour that can be collected by the dehumidifier in an extremely rapid and effective manner. The dehumidifier is therefore the best response to the problems involving excess humidity.

## Presentation

This dehumidifier is an appliance with combined operation (dehumidification + heating) that allows a rapid and effective decrease in ambient relative humidity. Combined operation is ideal for achieving a quick effect at low temperatures (below 10°C). In such conditions, in fact, heating evaporates the moisture condensed on walls, furniture and objects. Subsequently, the vapour can be effectively removed by the dehumidifier. This is a compact appliance, fitted with handles to make it easily transportable. It is recommended for use in all environments with problems of excess humidity, such as kitchens, bathrooms, laundries, basements, etc. Combined operation is perfect for drying clothes (COMBI function).

**Carefully read this instruction booklet before installing and using the appliance. This is the only way to ensure the best results and maximum safety.**

### Advantages:

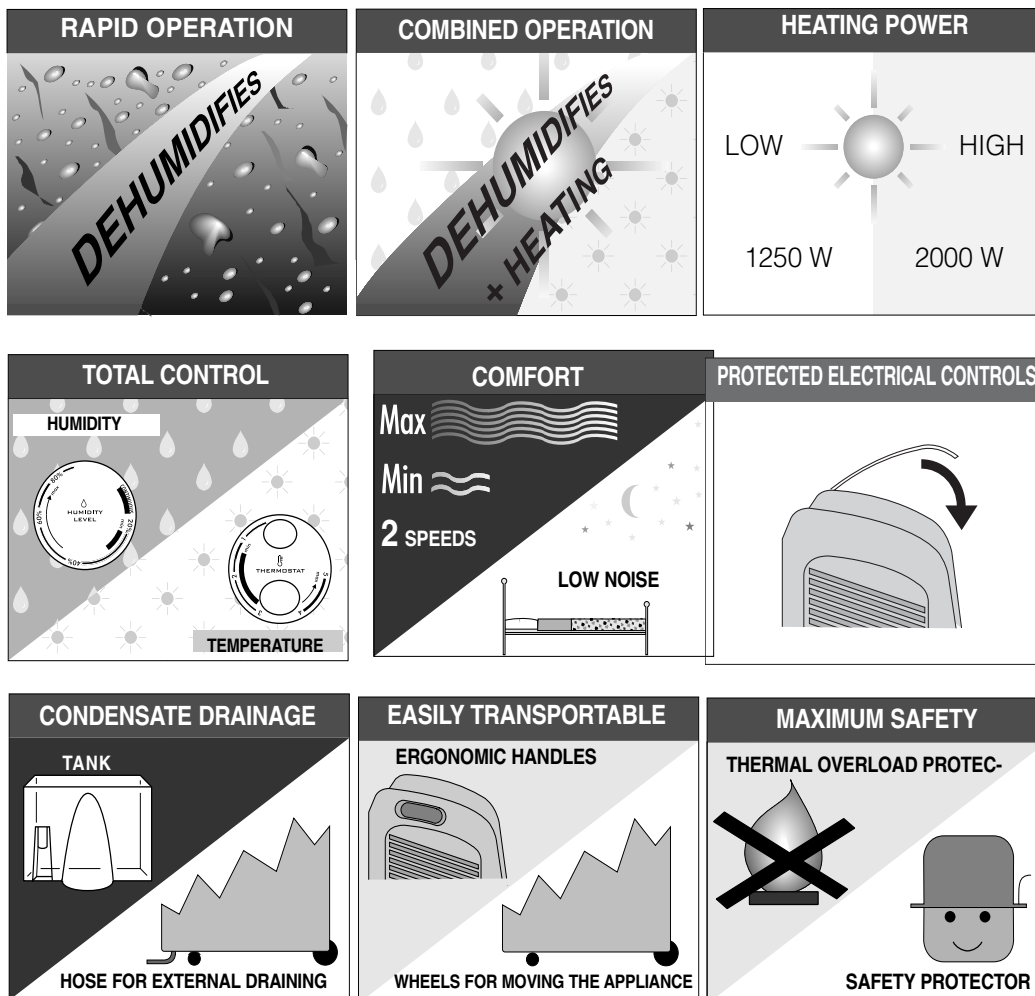

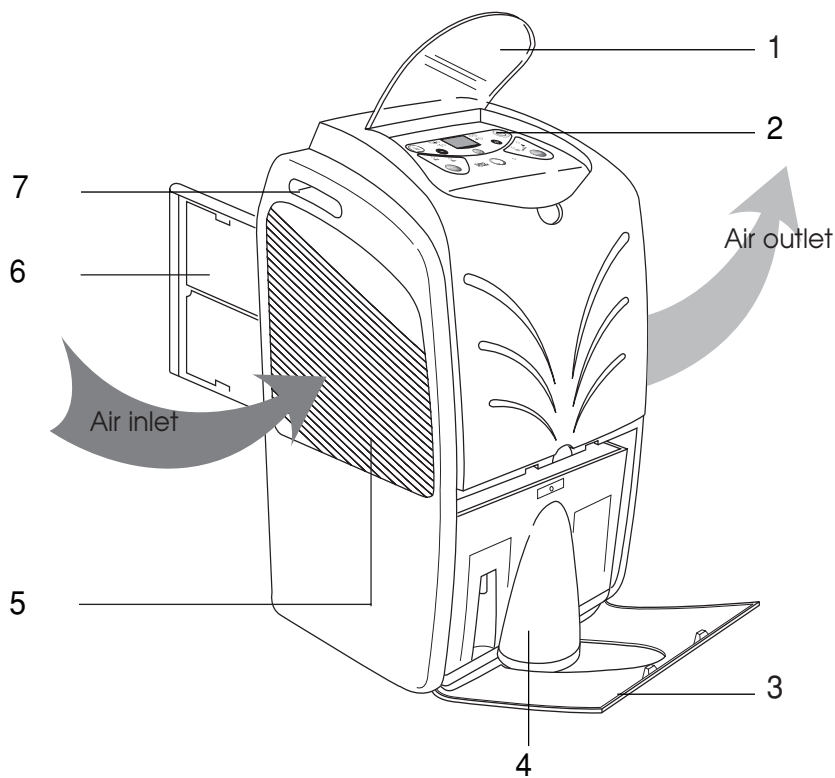

# Description/Accessories



ENGLISH

- 1. Control panel cover
- 2. Control panel
- 3. Tank door
- 4. Condensate collection tank
- 5. Air intake grille
- 6. Air filter
- 7. Lifting handle

Accessories	Description	No. of items supplied
	condensate drain hose	1 (2 m.)
	rubber bung	1

## Warnings

### Warnings

- Use this appliance only as described in this instruction manual. As with any electrical appliance, whilst the instructions aim to cover as many eventualities as possible caution and common sense should be applied when operating and installing this appliance.
- The appliance must be installed according to the legislation on electrical systems in force in each country.
- If the power cable is damaged, it must only be replaced by specialist personnel.
- This appliance is designed to dehumidify residential environments and must not be used for other purposes.
- It is dangerous to modify or alter the characteristics of the appliance in any way.
- If the appliance requires repair, always contact a Service Centre authorised by the manufacturer. Always insist on original spare parts. Repairs carried out by unauthorised personnel may be dangerous and invalidate the guarantee.
- This appliance must be used exclusively by adults. Do not allow children to play with the appliance.
- The appliance must be connected to an efficient earth system. Have your electrical circuit checked by a qualified electrician.
- Do not use extension cords.
- Before cleaning or maintenance operations, always unplug the appliance from the power socket.
- Do not move the appliance by pulling the power cable.
- Do not install the appliance in rooms containing gas, oil or sulphur. Do not install near sources of heat.
- Keep the appliance at least 50 cm away from flammable substances (alcohol etc) or pressurised containers (e.g. aerosol cans).
- Do not rest heavy or hot objects on top of the appliance.
- Clean the air filter regularly.
- Always transport the appliance upright or resting on one side. Remember to drain the tank before moving the appliance.
- R134a is a refrigerant that complies with the EEC environmental standards; nonetheless, the refrigerant circuit in the appliance should not be perforated. At the end of its working life, consign the appliance to a specialist collection centre.
- The materials used for packaging can be recycled. You are therefore recommended to dispose of them in special differentiated waste collection containers.

### Technical service

Keep the list of Service Centres and identify the Centre nearest you.

### Electrical connections

**After moving the appliance, wait at least an hour before turning it on again.**

Before plugging the appliance into the power socket, check that:

- The mains power supply corresponds to the power supply indicated on the rating plate.
- The power socket and electrical circuit are adequate for the appliance.
- The power socket matches the plug. If this is not the case, have the plug replaced by a qualified electrician;
- The power socket is adequately earthed.

# Installation

**P**osition the appliance in the room to be dehumidified:  
A free space of at least 50 cm must be left to the sides of the humidifier, so as not to block the circulation of air.

The condensate can be drained in one of the following ways:

**A) Draining into the tank**

The condensate can be drained directly into the tank located inside the appliance (Fig. 1).  
The tank can be easily removed and has a handle making it simple to carry and empty.

fig. 1

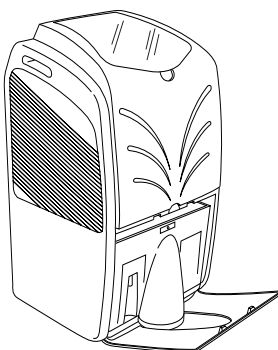

**B) Continuous external draining**

If the appliance is to be operated for long periods but you are unable to empty the tank, it is recommended to use the continuous drain facility.

- 1) Remove the rubber bung from the spout.
- 2) Drill the inside of the drain spout using a narrow drill bit. Fig. 2.
- 3) Fasten the rubber hose to the spout. To do this, open the door, remove the tank, pass the drain hose supplied through the opening between the door, slightly inclined, and the bottom of the appliance, then reposition the tank and insert the hose on the tank spout (Fig. 3).
- 4) Close the door.
- 5) Make sure that the hose is not higher than the spout, otherwise water will remain in the tank; also check that the hose is not choked.

**N.B.:** Keep the rubber bung. You will need it to plug the hose or close the spout if you revert to draining into the tank. (see point A)

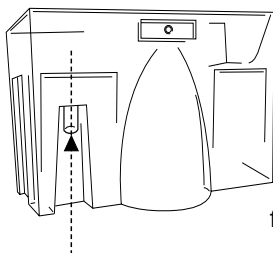

fig. 2

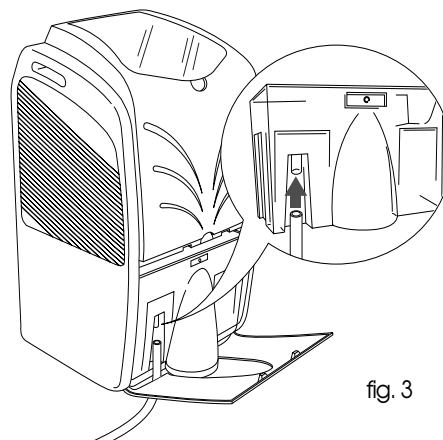
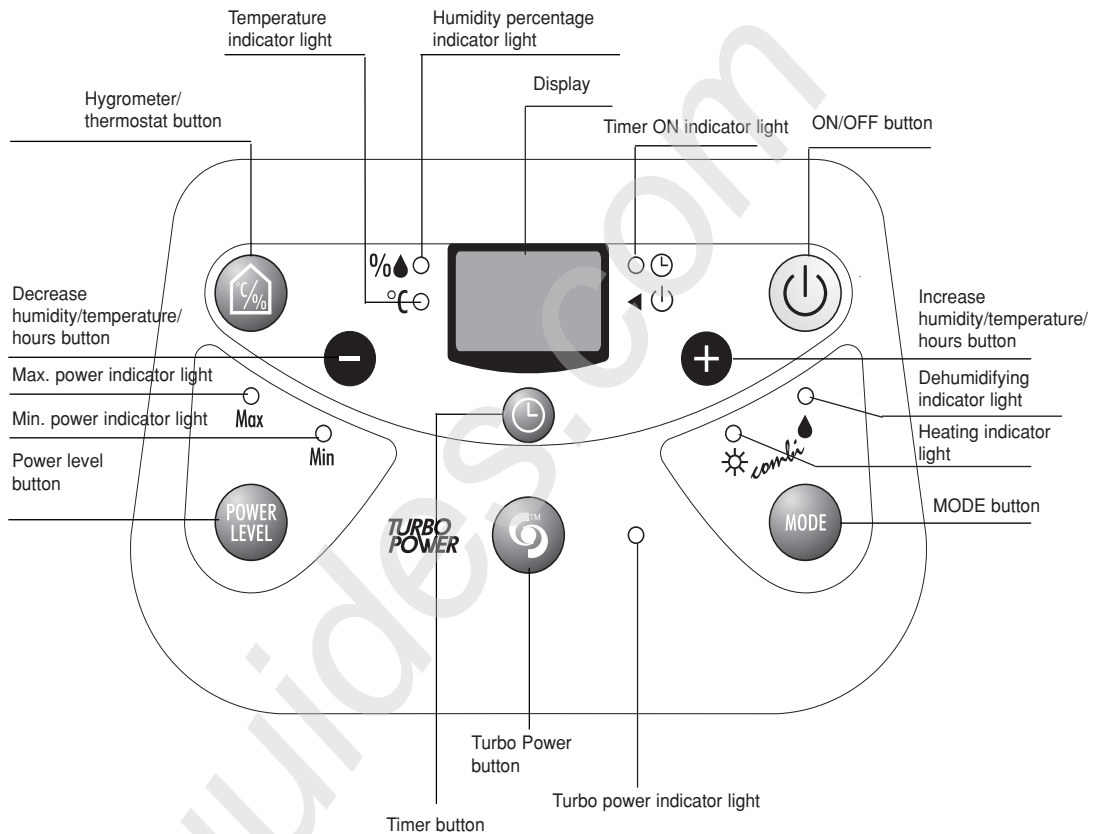

fig. 3

## Description of the controls/Indicator lights



### "ON/OFF" button

Used to start the appliance.

### "MODE" button

Used to select the "dehumidification" function, the "heating" function or the "combi" function (dehumidification + heating).

### "TURBO POWER" button

Used to activate the "turbo power" function

## The buttons



### “P” POWER LEVEL” button

Used to select the power level (MIN/MAX).



### Hygrometer/thermometer button

Used to display, in sequence for 2 secs., the ambient humidity, with a tolerance of +/- 5% (“%” light flashing) and the ambient temperature, with a tolerance of +/- 1% (“°C” light flashing).



### Timer button

Used to set the number of appliance operating hours (maximum 24).



### Increase/decrease humidity/temperature/hours

In dehumidification mode, these buttons are used to adjust the desired humidity level, with 5% steps, and in heating mode to set the desired temperature; they are also used to set the timer.

## Display

Meaning of the codes that may be shown on the display:

1. “- -” Indicates that the appliance is in Standby mode.
2. “TP” Indicates that the appliance is operating in TURBO POWER mode.
3. “FT” Indicates that tank is not fitted, is full or is positioned incorrectly.
4. “DF” Indicates that the appliance is operating at low temperature. In this mode, ventilation cycles are alternated with dehumidification cycles to avoid the formation of frost. For use in particularly cold environments, heating is recommended, so as to raise the ambient temperature even by just a few degrees. This allows the dehumidifier to operate in conditions that improve its performance and accelerate the dehumidification process.
5. “PF” Indicates that there may be fault with the probes, or that the ambient humidity is low.

## The indicator lights

### **H**umidity percentage indicator light

If on indicates that the display is showing the humidistat reading. If flashing, indicates that the display is showing, for 2 secs., the ambient humidity (pressing the thermometer/hygrometer button)

### **T**emperature indicator light

If on indicates that the display is showing the thermostat reading (heating function only). If flashing, indicates that the display is showing, for 2 secs., the ambient temperature (pressing the thermometer/hygrometer button, after the ambient humidity reading)

### **T**imer indicator light

If on indicates that the timer function is active.

### **D**ehumidifying indicator light

Indicates that the appliance is operating in dehumidification mode

### **H**eating indicator light

Indica che l'apparecchio sta funzionando in modalità riscaldamento

### **D**ehumidify + heating indicator light

Indicates that the appliance is operating in COMBI mode.

### **Min** **M**inimum power indicator light

Indicates that the MIN power level has been selected

### **Max** **M**aximum power indicator light

Indicates that the MAX power level has been selected

### **T**urbo power indicator light

Indicates that the appliance is operating in turbo power mode. When this is on, all the other indicator lights are off, except for the timer indicator light, if the function is active.



## Selecting the functions

### How to dehumidify (dehumidification only function)

- 1) Plug the appliance into a power socket.
- 2) The display shows "--" to indicate that the appliance is in standby and therefore ready for operation. If the message "Ft" is displayed, empty the tank or position it correctly.
- 3) Press the ON/OFF button.
- 4) Press the "mode" button and choose the dehumidification function ( "💧" indicator light on). The display shows the relative humidity set point.
- 5) Press the "+" or "-" button to set the desired humidity (30% means a dry environment, 80% a humid environment).
- 6) Press the "power level" button to select the desired dehumidification power level (MIN/MAX).
- 7) Press the "📊" button to display, in sequence, the ambient relative humidity ( "%💧" indicator light flashing) and the ambient temperature ( "°C" indicator light flashing).
- 8) When the appliance reaches the humidity set point, it will stop and the periodical ventilation function will start, so as to ensure a correct relative humidity reading. As soon as the humidity increases above the set point, the appliance will automatically resume dehumidification operation.

ENGLISH



### How to heat

- 1) Plug the appliance into a power socket.
- 2) The display shows "--" to indicate that the appliance is in standby and therefore ready for operation. If the message "Ft" is displayed, empty the tank or position it correctly.
- 3) Press the ON/OFF button.
- 4) Press the "mode" button and choose the heating function ( "☀️" indicator light on). The display shows the temperature set point.
- 5) Press the "+" or "-" button to select the desired temperature.
- 6) Press the "POWER LEVEL" button to select the desired heating power level (MIN/MAX).
- 7) Press the "📊" button to display, in sequence, the ambient relative humidity ( "%💧" indicator light flashing) and the ambient temperature ( "°C" indicator light flashing).
- 8) When the appliance reaches the temperature set point, it will stop and the periodical ventilation function will start, so as to ensure a correct temperature reading. As soon as the temperature increases above the set point, the appliance will automatically resume heating operation.



### Combined operation, (dehumidification 💧 + heating ☀️ )

- 1) Plug the appliance into a power socket.
- 2) The display shows "--" to indicate that the appliance is in standby and therefore ready for operation. If the message "Ft" is displayed, empty the tank or position it correctly.
- 3) Press the ON/OFF button.
- 4) Press the "mode" button and choose the COMBI function ( "💧 + ☀️" indicator light on). The display shows the humidity set point set.
- 5) Press the "+" or "-" button to select the desired humidity level.

## Selecting the functions

- 6) Press the **"power level"** button to select the desired dehumidification + heating power level (MIN/MAX).
- 7) Press the "  " button to display, in sequence, the ambient relative humidity (" % " indicator light flashing) and the ambient temperature (" °C " indicator light flashing).
- 8) When the appliance reaches the humidity set point, it will stop and the periodical ventilation function will start, so as to ensure a correct humidity reading. As soon as the humidity increases above the set point, the appliance will automatically resume dehumidification plus heating operation.

### Turbo power

- 1) Plug the appliance into a power socket.
- 2) The display shows "- -" to indicate that the appliance is in standby and therefore ready for operation. If the message "FT" is displayed, empty the tank or position it correctly.
- 3) Press the  button.
- 4) The turbo power function is an automatic dehumidification + heating function that is used when wanting to operate the appliance at maximum power. In this mode, the humidity and temperature set points are deactivated. In any case, a maximum temperature protection device stops the heating function in the event of excess temperature, while still guaranteeing the dehumidification function. The appliance resumes heating operation as soon as the temperature falls back below the maximum value. The display shows the message "t P". Neither the humidity or temperature set point nor the power level can be changed. To deactivate the turbo power function, simply press the  button again.

### How to program the delayed start function

- Plug the appliance into a power socket and press the ON/OFF button; then select the desired function and power level.
- Press the ON/OFF button again: the appliance will go into Standby mode.
- Press the timer button: the two centre segments "- -" will flash on the display.
- Use the + or - button to set the number of hours after which the appliance should start operation. The timer indicator light comes on. The appliance can be set to start in the following 24 hours.

### How to program the delayed stop function

- The delayed stop function can be set in any operating mode (dehumidification/heating/combi/turbo power).
- Press the timer button: the two centre segments "- -" will flash on the display.
- Use the + or - button to set the number of hours after which the appliance should stop operation.

The timer indicator light comes on. At the pre-set time, the appliance will stop and go into Standby mode.

## Cleaning

### Maintenance

Always unplug the appliance from the power socket before performing any cleaning or maintenance operations. For safety reasons, never wash the dehumidifier using a jet of water.

### Cleaning the cabinet

- Clean the appliance using a damp cloth then dry with a dry cloth.
- Never use petrol, alcohol or solvents to clean the appliance.
- Never spray the appliance with insecticides or similar. These could cause the paint to flake or plastic parts to warp.

### Cleaning the air filter

If the filter is dirty, air circulation is compromised and the efficiency of the dehumidifying and air purifying functions decreases. It is therefore good practice to clean the filter at regular intervals. The frequency depends on the duration and conditions of operation.

- -It is good practice to clean the filter every week.
- -To remove the air filter, pull it out (Fig. 4).
- -Use a vacuum cleaner to remove dust accumulations from the filter. If the filter is very dirty, wash in warm water and rinse several times.

The temperature of the water must not exceed 40°C.

After washing the filter, allow it to dry completely before repositioning it.

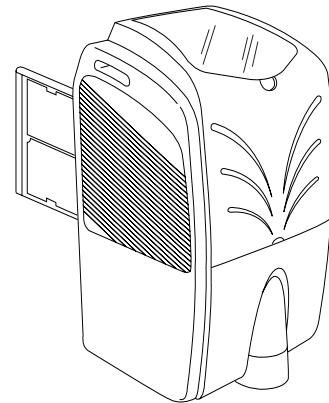

fig. 4

### If the appliance is not used for long periods

- After having unplugged the appliance from the power socket, empty the tank.
- Clean and reposition the filter.
- Cover the appliance with a plastic bag so that dust does not build up.

#### ELECTRICAL CONNECTION (UK ONLY)

- A) If your appliance comes fitted with a plug, it will incorporate a 13 Amp fuse. If it does not fit your socket, the plug should be cut off from the mains lead, and an appropriate plug fitted, as below.

**WARNING:** Very carefully dispose of the cut off plug after removing the fuse: do not insert in a 13 Amp socket elsewhere in the house as this could cause a shock hazard.

With alternative plugs not incorporating a fuse, the circuit must be protected by a 15 Amp fuse.

**WARNING - THIS APPLIANCE MUST BE EARTHED**

#### IMPORTANT

The wires in the mains lead are coloured in accordance with the following code:

Green and yellow:	Earth
Blue:	Neutral
Brown:	Live



If the plug is a moulded-on type, the fuse cover must be re-fitted when changing the fuse using a 13 Amp Asta approved fuse to BS 1362. In the event of losing the fuse cover, the plug must NOT be used until a replacement fuse cover can be obtained from your nearest electrical dealer. The colour of the correct replacement fuse cover is that as marked on the base of the plug.

- B) If your appliance is not fitted with a plug, please follow the instructions provided below:

As the colours of the wires in the mains lead may not correspond with the coloured markings identifying the terminals in your plug, proceed as follows:

The green and yellow wire must be connected to the terminal in the plug marked with the letter E or the earth symbol  $\perp$  or coloured green or green and yellow.

The blue wire must be connected to the terminal marked with the letter N or coloured black.

The brown wire must be connected to the terminal marked with the letter L or coloured red.

## Troubleshooting

Check the following points before calling your local authorised Service Centre.

Problem	Cause	Solution
The appliance is operating in dehumidification mode (light on), but the humidity does not decrease	<ul style="list-style-type: none"> <li>•the filter is blocked</li> <li>•the temperature or humidity in the room are too low</li> <li>•the room is too large</li> <li>•too many sources of humidity in the room (pots of boiling water, etc.)</li> <li>•humidistat set too high</li> </ul>	<ul style="list-style-type: none"> <li>•clean the filter</li> <li>•in certain conditions, it is normal for the appliance not to dehumidify (in these cases, it is recommended to heat the environment)</li> <li>•decrease the humidity set point</li> </ul>
The appliance is operating in heating mode, but does not heat the air	<ul style="list-style-type: none"> <li>•the room is too large</li> <li>•the windows are open</li> <li>•the electric heater protector has been activated</li> <li>•thermostat set too low compared to the ambient temperature</li> </ul>	<ul style="list-style-type: none"> <li>•close the windows</li> <li>•to resume operation, switch the appliance off for a few minutes, eliminate the cause of the overheating, then switch the appliance back on. If the problem persists, call the Service Centre</li> <li>•increase the humidity set point</li> </ul>
The appliance does not work for around 3 minutes when restarted	<ul style="list-style-type: none"> <li>•the appliance's safety device has been activated</li> </ul>	<ul style="list-style-type: none"> <li>•wait for 3 minutes to pass</li> </ul>
<p>The display shows "FT"</p> <p>The display shows "DF"</p> <p>The display shows "PF"</p>	<ul style="list-style-type: none"> <li>•the tank is not fitted</li> <li>•the tank is full</li> <li>•the tank is positioned incorrectly</li> <li>•the temperature in the room is too low</li> <li>•one of the sensors on the appliance is faulty</li> </ul>	<ul style="list-style-type: none"> <li>•fit the tank</li> <li>•empty the tank</li> <li>•position the tank correctly</li> <li>•increase the ambient temperature, even slightly</li> <li>•call the Service Centre</li> </ul>

## Technical specifications

Power supply voltage	See rating plate
Power input in dehumidification mode	"
Power input in heating mode	LOW: "
	HIGH: "
Maximum power input	"
Maximum current input	"
Refrigerant	R134a
Air flow (min, max)	210/300 m <sup>3</sup> /h
Frost protection device	si
Thermostat	si
Humidistat	si
Fan speeds	2
Electric heater thermal overload protector	yes
Compressor protector	yes
Tank controller	yes
Air filter	yes
Dimensions WxHxD	365x610x360 mm
Weight (net)	21,5 kg.
Tank capacity	5.5 litres

ENGLISH

Operating limits:	Heating	Dehumidification
• temperature	Max. 27°C	5° - 32°
• relative humidity	Max. 90%	30 - 95%

Note: The quantity of moisture contained in the air decreases as the temperature decreases. For example, at 5°C and 80% relative humidity, there are less than 5 grams of water vapour per cubic metre of air. To resolve problems of humidity at low temperatures, it is recommended to use the COMBI function.