

---

**DEHUMIDIFIER**  
**DESHUMIDIFICATEUR**  
**DESHUMIDIFICADOR**

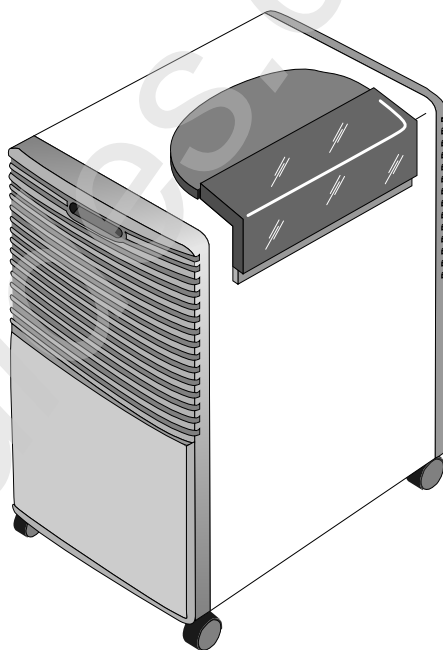

**Instructions for use**  
**Mode d'emploi**  
**Instrucciones para el uso**

---





## IMPORTANT SAFEGUARDS

When using electrical appliances, basic safety precautions should always be followed, including the following:

- Read all instructions.
- This appliance is designed to dehumidify domestic living areas, and must not be used for other purposes.
- The appliance must not be modified in any way, as any modifications may be extremely dangerous.
- If the appliance requires repair, always contact a Service Centre authorized by the manufacturer. Always insist on original spare parts. Repairs carried out by non-qualified personnel may be dangerous and render the warranty null and void.
- This appliance must be used by adults only. Do not allow children to play with the appliance.
- The appliance must be adequately grounded. Have your electrical circuit checked by a qualified electrician.
- Do not use extension power cables.
- Always remove the plug from the socket before performing cleaning or maintenance operations.
- Do not move the appliance by pulling the power cable.
- Do not install the appliance in areas containing gas, oil or sulphur. Do not install the appliance near sources of heat.
- Do not place heavy or hot objects on the top of the appliance.
- Clean the air filter at least once weekly.
- The appliance must always remain upright or laid on one side during transportation. Remember to drain the tank before transporting the appliance..
- **After transporting the appliance, wait 24 hours before using it.**

**THIS PRODUCT IS FOR HOUSEHOLD USE ONLY**

**SAVE THESE INSTRUCTIONS**

**Read this instruction booklet carefully before installing and using the appliance. In this way, you will obtain the best possible results and maximum operating safety.**

## Presentation

The dehumidifier removes humidity from the air in the areas in which it is installed. The appliance is compact and fitted with wheels and handle which facilitate its movement.

This appliance is recommended for all rooms in which excessive humidity is liable to build up, e.g. basements, kitchens, laundry rooms, cellars etc.

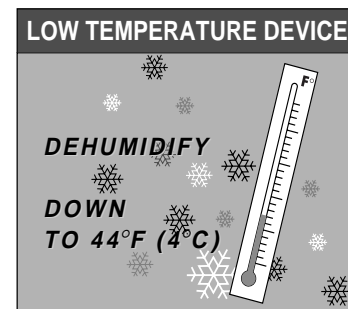
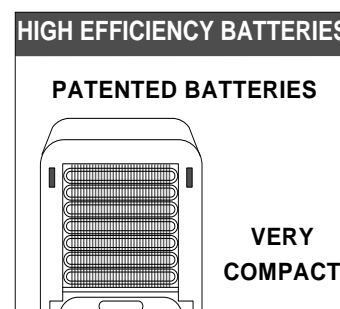
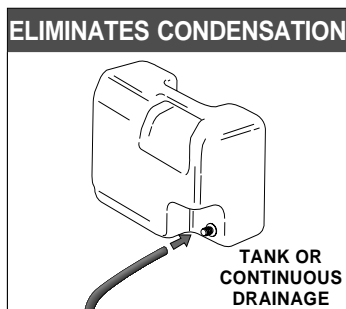
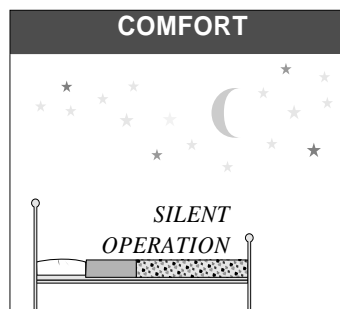
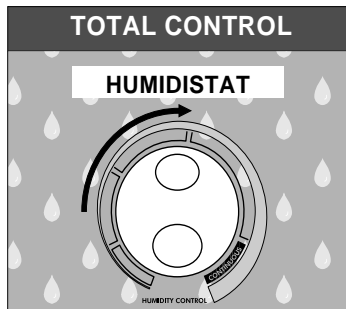
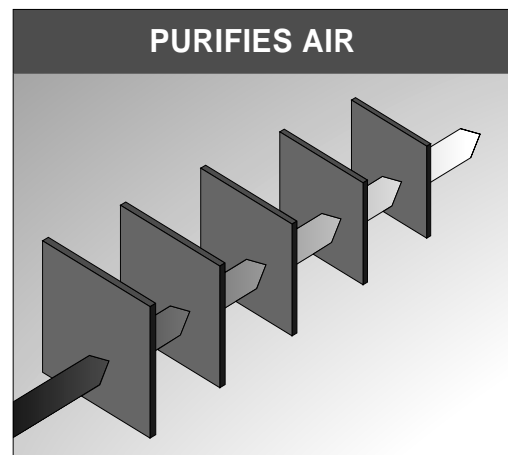
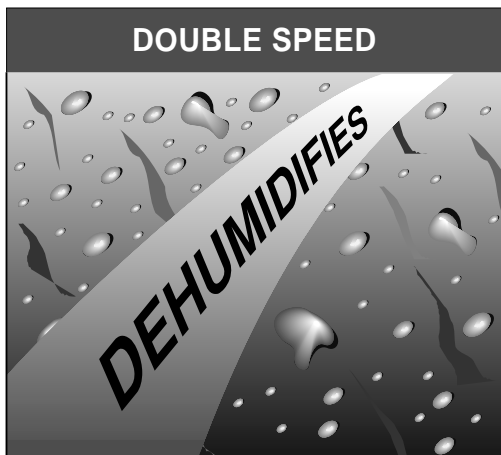

## Description

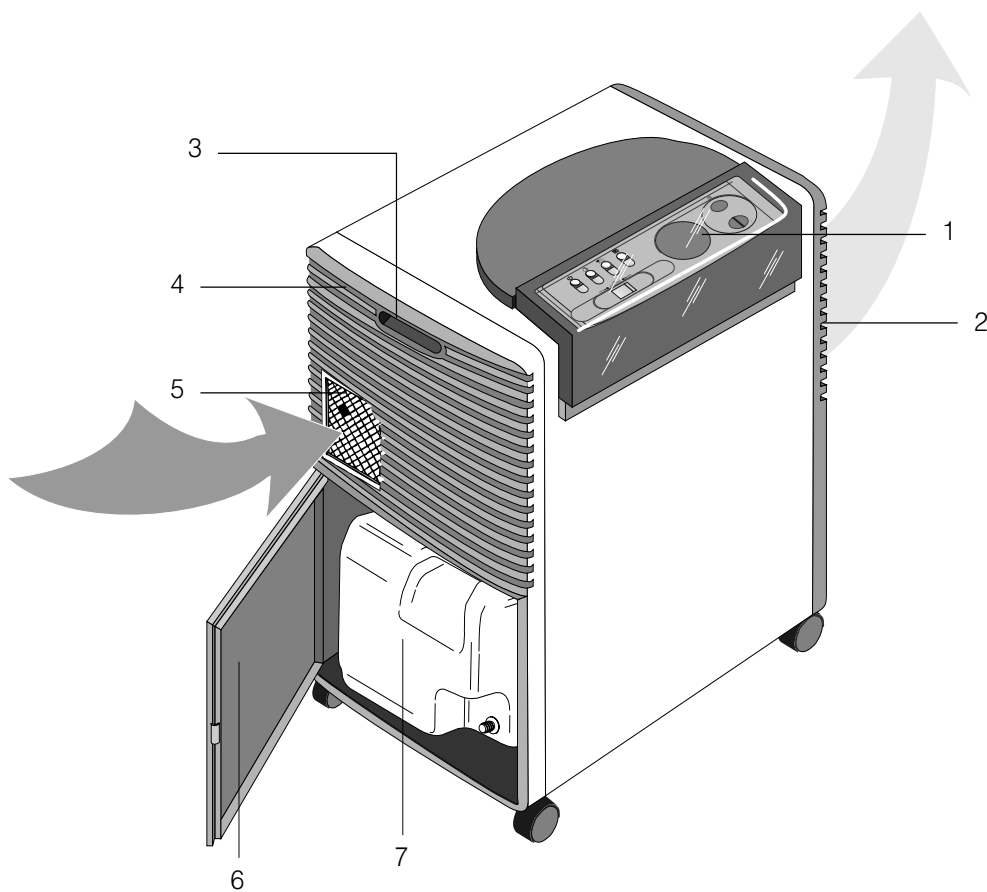

1. Panel cover and control panel
2. Air outlet grille
3. Lifting handle
4. Air intake grille
5. Air filter
6. Tank access panel
7. Tank

### Technical characteristics

Power supply	see rating label
Absorbed power	see rating label
Absorbed current	see rating label
Moisture removed	see rating label
Volume of air dehumidified	see rating label
Coolant	R22
Humidistat	yes
Capacity of tank	13 pints / 6 litres
Operating limits:	
• temperature	44° - 90 °F (7° - 32° C)
• relative humidity	40 - 95 %
Standard operating conditions: 80°F - 60% RH	

### IMPORTANT

#### When to use your dehumidifier

This dehumidifier is designed to bring humidity level within a comfort zone (from 45% to 65% relative humidity. This is the mid range of the humidistat setting).

The chart (shaded area) indicates when a dehumidifier should not be used since the humidity level is low enough.

Operating a dehumidifier under the conditions shown in the shaded area may cause frosting or icing-up of the coils which will prevent the collection of any moisture.

Experts have established that optimal atmospheric conditions, both for physical health and the preservation of furniture and other items, vary between 45% and 60% relative humidity. It is therefore advisable to keep rooms within these values.

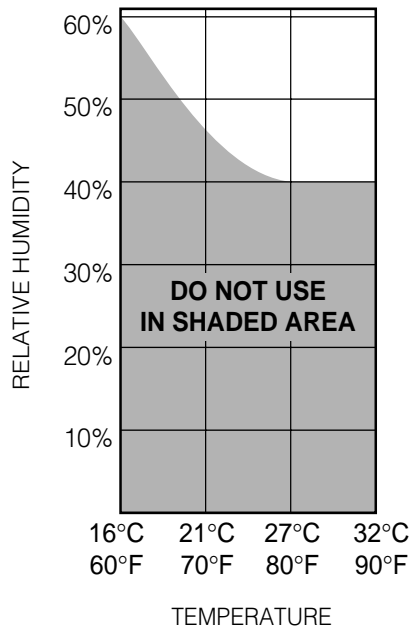

#### Caution

**Before operating unit check that float is suspended freely inside the bucket.**

## Installation

Place the appliance in the room that you wish to dehumidify.  
It is essential to leave a space of at least 20 inches around the appliance in order to ensure adequate ventilation.  
The condensation can be discharged in two ways:

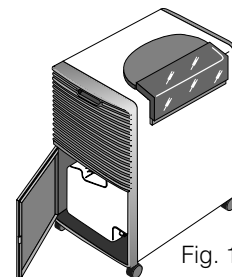

Fig. 1

### A) Discharge into the tank

The condensation generated by the dehumidifier can be discharged directly into the tank which is located in the back side of the appliance (fig. 1).

The tank which has an ergonomical handle, is very easy to carry and to empty without spilling.

### B) Continuous drainage

The condensation can be continually drained out of the tank by fitting a hose (5/8' inch Ø) directly to the pipe of the tank. (Fig.2). It is very easy to drill a hole in the tank: remove the rubber cap, go through the pipe and drill the tank (Fig.3). Fix the rubber hose to the pipe.

Remember to save the rubber cap: it can be used to close the tube or the pipe when discharging into the tank.

N.B. If you want to go back collecting the condensation in the tank, remove the hose and insert the rubber cap into the pipe (Fig. 4).

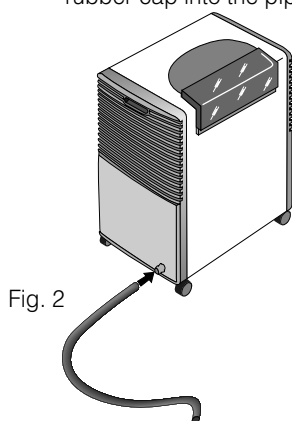

Fig. 2

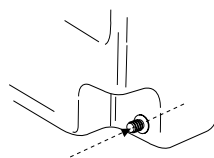

Fig. 3

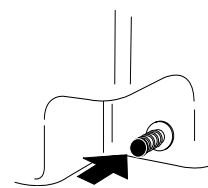

Fig. 4

## Tank control system/Tank Full

The De'Longhi dehumidifiers are equipped with a special device which controls the tank.

A warning lamp, on the control panel, lights to advise the user if:

1. the tank is full → empty the tank
2. the tank is missing → replace the tank
3. the tank is not positioned properly → reposition it correctly
4. you are using continuous drainage and there is an obstruction in the hose → remove the obstruction and empty the tank.

Once the situation is remedied, the warning light will switch off and the unit will restart automatically.

## Low temperature device

The appliance is equipped with a special electronic device which makes it operate in low temperature rooms (down to 44°F -7°C). The low temperature device lets the appliance work cycling between dehumidification/ventilation. When operating in this function, the low temperature pilot light is on.

## Safe start device

The appliance is supplied with a safe start device which delays the compressor start when turning on the appliance, thus ensuring a longer life to the compressor.

When you turn on the appliance to dehumidify, the ventilation only function will start and after few minutes the compressor will also turn on. After that the appliance will start operating as dehumidifier.

## Electrical connections

**Before connecting the appliance to the power supply, check the following:**

- The main power supply must correspond to the power supply shown on the rating plate.
- The power socket and the electrical circuit must be adequate to supply the appliance.
- The power socket must match the plug. If not, have the plug replaced by qualified personnel.
- The power socket must be adequately earthed.

The manufacturer accepts no responsibility if these safety regulations are not complied with.

## Description of the controls

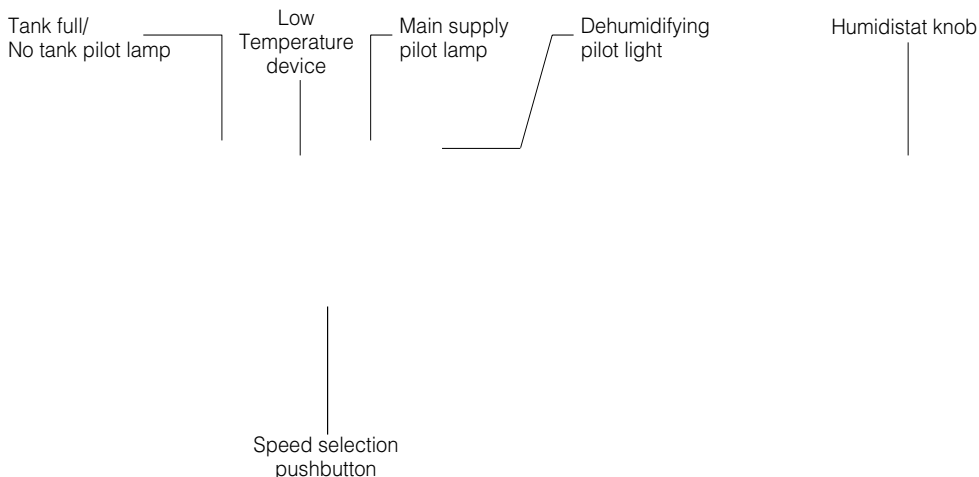

## Using the dehumidifier

- 1) Plug the appliance into the electrical outlet. The pilot lamp lights to show that the appliance is switched on.
- 2) Check that the tank control lamp is off.
- 3) Turn the humidity control to the setting desired.
- 4) To switch off the appliance, turn the humidity control anti-clockwise to the "OFF" position.

**Note:** When first using the dehumidifier, turn the Humidity Control clockwise to CONTINUOUS. Let the unit run continuously at this setting. Observe the dampness conditions in the area being dried. When you feel comfortable and the dampness odors are gone, adjust the Humidity Control to the position between RANGE and COMFORT. That provides a "dryness" condition suitable to your needs/comfort.

At first, the dehumidifier will remove large amounts of moisture. It will continue to do so until the relative humidity is reduced to a point where moisture damage will not occur. Then, the amount of moisture removed from the air will be less. This indicates that the dehumidifier is operating effectively and is maintaining the relative humidity at the desired level. Judge the performance of the dehumidifier by the elimination of dampness and dampness odors, not by the amount of water being deposited in the bucket.

## Where to use the dehumidifiers

The dehumidifier is an extremely useful instrument for a number of situations in the house such as:

BASEMENT OR ANY PLACE, when air is full of dampness, as this may cause feelings of DISCOMFORT, or damages (use MAX speed for high air treatment)

LAUNDRY, preventing the formation of unpleasant odors. (use MAX speed for high air treatment)

BEDROOMS, LIVINGROOMS and other areas of the house the dehumidifier prevents damage to walls and furnitures (use MIN speed for comfort noiseless working)

In the KITCHEN, this equipment helps get rid of offensive odors and the condensation which forms while cooking (use MIN or MAX speed, according to noise comfort level.)



## Maintenance

Always remove the plug from the electrical outlet before performing any cleaning or maintenance operations. For safety, never use a jet of water to wash the appliance.

### Cleaning the cabinet

- Clean the appliance using a damp cloth and dry using a dry cloth.
- Never use petrol, methylated spirits or solvents to clean the appliance.
- Never spray the appliance with insecticides or similar products. These may cause the paint to flake or the plastic parts to become mis-shapen.

### Cleaning the air filter

- The filter should be cleaned weekly.
- The filter has a comfortable access and it's extremely easy to remove and replace it without using any tools (Fig. 5).
- Use a vacuum cleaner to remove the dust that builds up on the filter. If the filter is very dirty, wash it in warm water and rinse several times. The temperature of the water should not exceed 104°F. After washing the filter, allow it to dry completely before replacing it in the appliance.

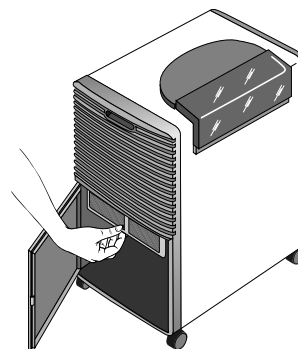

Fig. 5

### If the appliance is not used for long periods

- Disconnect the plug from the power socket and empty the tank.
- Clean and replace the filter.
- Protect the appliance from dust by covering with a large plastic bag.

## Troubleshooting

Before calling your local authorized Service Centre, check the following:

Problem	Cause	Solution
The dehumidifier does not switch on	<ul style="list-style-type: none"> <li>• the appliance is not plugged in</li> <li>• the humidistat is set to the minimum position</li> <li>• the tank is full</li> <li>• the tank is missing</li> <li>• the tank is not positioned properly</li> <li>• there is an obstruction in the hose when using continuous drainage</li> </ul>	<ul style="list-style-type: none"> <li>• insert the plug into the socket</li> <li>• adjust the humidistat to the desired position</li> <li>• empty the tank</li> <li>• replace the tank</li> <li>• position the tank correctly</li> <li>• remove the obstruction and empty the tank</li> </ul>
The appliance does not dehumidify	<ul style="list-style-type: none"> <li>• the filter is dirty</li> <li>• the temperature or humidity in the room is too low</li> </ul>	<ul style="list-style-type: none"> <li>• clean the filter</li> </ul>



## Limited Warranty

**What Does This Warranty Cover?** We warrant each appliance to be free from defects in material and workmanship. Our obligation under this warranty is limited to replacement or repair, free of charge at our factory or authorized service centers, of any defective part or parts thereof other than parts damaged in transit, which shall be returned to us, transportation prepaid. This warranty shall apply only if the appliance is used in accordance with the factory directions which accompany it, and on an Alternating Current (AC) circuit.

**How Long Does The Coverage Last?** This warranty runs for one year from the date of delivery and applies only to the original purchaser.

**What Does This Warranty Not Cover?** This warranty does not cover defects or damage of the appliance which result from repairs or alterations to the machine outside our factory or authorized service centers, nor shall it apply to any appliance which has been subject to abuse, misuse, negligence or accidents. Also, consequential and incidental damages resulting from the use of this product or arising out of any breach of contract or breach of this warranty are not recoverable under this warranty. Some states do not allow the exclusion or limitation of incidental or consequential damages, so the above limitation may not apply to you.

**How Do You Get Service?** If repairs become necessary or spare parts are needed, please write to:

De'Longhi America Inc.  
Park 80 West Plaza One  
Saddle Brook, N.J. 07663

or call Service Tel. No. 800-322-3848

The above warranty is in lieu of all other express warranties and representations; All implied warranties are limited to the applicable warranty period set forth above. This limitation does apply if you enter into an extended warranty in connection with De'Longhi. Some states do not allow limitations on how long an implied warranty lasts, so the above exclusions may not apply to you. De'Longhi does not authorize any other person or company to assume for it any liability in connection with the sale or use of its appliance.

**How Does State Law Apply?** This warranty gives you specific legal rights, and you may also have other rights which vary from state to state.