

Haier

What The World Comes Home To™

Dehumidifier Déshumidificateur Deshumidificador



HD306,HD458,HD658

User Manual

Manual de l'utilisateur

Manual del usuario



(HD458,HD658 Only)

HD Series Models:
(Features will vary by model)

Série HD Modèles:
(Les caractéristiques varient selon les modèles)

Series HD Modelos:
(Las características pueden variar con el modelo)

Before operating this dehumidifier,
please read these instructions completely.

SAFETY PRECAUTIONS

READ INSTRUCTIONS BEFORE USING

When using the dehumidifier, always follow basic precautions, including the following:

- This dehumidifier must be properly installed and grounded as described in this manual.
- Never operate this dehumidifier in an area that is likely to accumulate standing water. If this condition develops, disconnect the power supply before stepping into the water.
- Repair or replace immediately all electric service cords that have become frayed or otherwise damaged. Do not use a power cord that shows signs of damage along its length or either the plug or where it is connected to the appliance.
- Always unplug dehumidifier before servicing or moving the unit.

CAUTION

- Do not cover the machine's air vents.
- Do not allow children to climb on or play with the machine.
- Contact a professional for service and repair.

SAVE THESE INSTRUCTIONS

Thank you for using our Haier product. This easy-to-use manual will guide you in getting the best use of your dehumidifier.

Remember to record the model and serial number. They are on a label in back of the dehumidifier.

Model number

Serial number

Date of purchase

Staple your receipt to your manual. **You will need it to obtain warranty service.**

Before using your dehumidifier

Read this manual carefully. It contains instructions to help you use, maintain and enjoy your dehumidifier.

Electrical Safety

Grounding

This dehumidifier must be grounded. Grounding reduces the risk of electric shock by providing an escape wire for the electric current.

The power cord has a grounding wire with a grounding plug. Plug it into an outlet that is properly installed and grounded.

WARNING--Improper use of the grounding plug can result in a risk of electric shock. Call a qualified electrician if you don't understand the grounding instructions or if you are not sure if the dehumidifier is properly grounded. If the wall outlet is not grounded, please contact an electrician to have it replaced with a properly grounded outlet.

Do not, under any circumstances, cut or remove the third (ground) prong from the power cord.

Adapter Plug

Because most 2-prong outlets are not grounded, we strongly advise against using an adapter plug.

However, a temporary connection may be made where local codes permit and if the 2-prong wall outlet is properly grounded. Make sure the larger prong of the adapter goes into the large slot to provide proper polarity.

FOR PROPER GROUNDING

1. Ground the adapter to the outlet by using the outlet cover screw to secure the ground terminal to the outlet box.
2. Please confirm the outlet is grounded through the house wiring. If the grounding connector breaks. **DO NOT USE** the dehumidifier until a proper ground has again been made.

Extension Cord

If an extension cord is required to reach the nearest wall receptacle, use only a UL-listed, 3-wire, grounding type, 16 AWG, 15A, 125V appliance extension cord.

Familiarize yourself with the controls on the dehumidifier

Humidity Control

When starting the dehumidifier, turn knob to the right until unit turns on. Adjust knob to desired level of dryness – turn the control knob clockwise for more drying. In the MAX position, the unit will run longer and extract more moisture from the air.

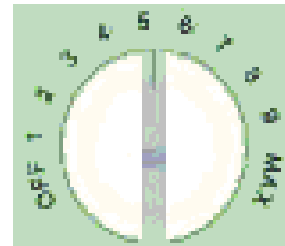

HUMIDITY
SETTING

Red Indicator Light

(BUCKET FULL indicator)

When light comes on, automatic flow control turns the unit off. Turn the humidity control off before emptying the bucket.

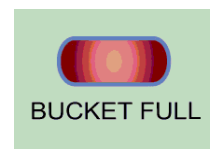

Fan Speed

High speed for higher moisture removal.
Low speed for quieter operation.

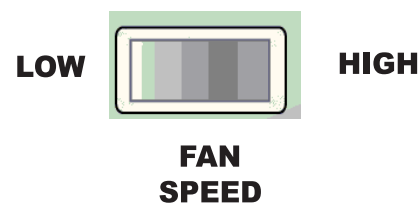

Auto Frost Sensor

(Built in)

When temperature gets down to 60°F or lower, ice may form on the evaporator coils preventing removal of moisture. The FROST CONTROL stops the compressor when this happens but allows the fan to continue running. When the ice is no longer present it starts the compressor.

Features/Care & Cleaning

It is normal for the surrounding air to become slightly warmer as the dehumidifier operates. This warming effect further reduces the relative humidity of the surrounding air. There are 2 ways to remove collected water.

1. Using the bucket

When the bucket is full, the red indicator light, "BUCKET FULL" will go on. You must turn the humidity control off before removing the bucket. Wait a few minutes to allow the water to stop dripping. Use both side handles to lift and remove bucket. Pour water through opening and replace bucket.

Note: All models are equipped with built-in water overflow control. The unit will shut down when the water level reaches a maximum level can be adjusted by lifting the red plunger located on the top of the bucket. Turning the plunger clockwise about two turns will raise the water level. Turning it counter-clockwise will lower the maximum water level.

Warning:

Make sure the drain cap be tightened before running the unit.

Using the bucket

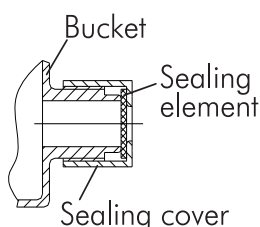

Using a hose

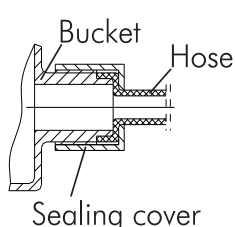

2. Continuous Drainage

The continuous drainage function can be activated using the following steps.

1. Remove the bucket and remove the plastic cap on the back of bucket. Then take the rubber insert out of the cap (Keep the rubber insert well for use later). See Fig. #1

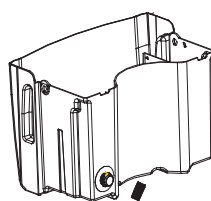

Fig. #1

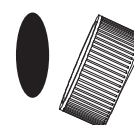

Fig. #2

2. Using the supplied hose, Thread the hose through the cap opening and add the washer to the cap. Screw the cap to the threaded matching connector on the bucket. Make sure to use the washer or the connection may leak. See Fig. #3

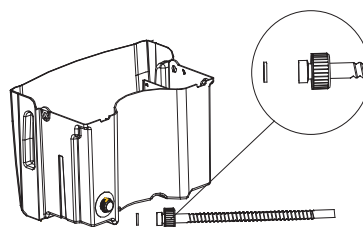

Fig. #3

3. Remove the plastic cap. See Fig. #4

4. Thread the hose through the round hole and extend the hose to the back of the unit. See Fig. #5

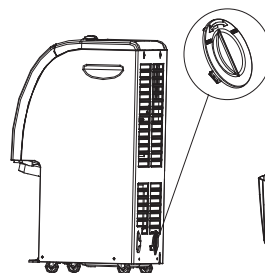

Fig. #4

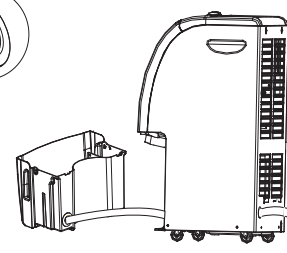
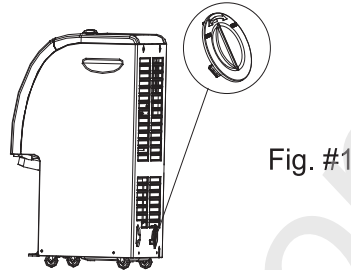

Fig. #5

5. Place the bucket in its original position.

If you would like to install the purchased garden hose, pls follow the below steps:

1. Remove the plastic cap on the back of the unit. (Fig. #1)



2. Take out the bucket, pull the purchased garden hose through the round hole and extend the hose to the front of the unit.(Fig. #2)

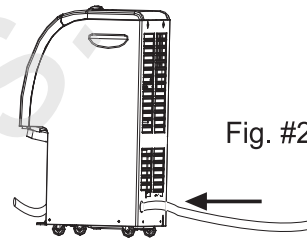

3. Remove the plastic cap on the bucket.(Fig. #3)

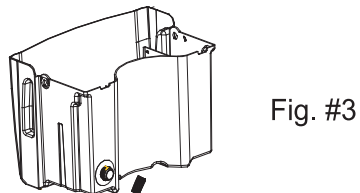

4. Screw the hose to the threaded matching connector on the bucket tightly.(Fig. #4)

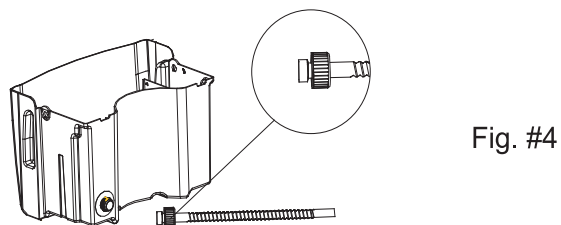

5. Place the bucket in its original position.

Features/Care & Cleaning

Proper use and care

- Place the dehumidifier in a location that does not restrict air flow into the rear coil or out the front grille.
 - The dehumidifier must be operated in an enclosed area to be most effective. Close all doors, windows and other outside openings to the room.
 - A dehumidifier operating in a basement will have little or no effect in drying an adjacent enclosed storage area, such as a closet, unless there is adequate circulation of air in and out of the area.
 - when stop the model, please be noticed that you should restart it at least 3 minutes later, which is benefit for the machine.
 - Turn the dehumidifier off and remove the plug from the wall outlet before cleaning. Use water and a mild detergent to clean the inlet and outlet grilles. Do not use bleach or abrasives.
- The air filter is on the front of the dehumidifier. It should be checked and cleaned at least every 2 to 3 weeks or when needed.
- To remove filter: Unplug the unit, remove the bucket and lift out the filter. Clean the filter with a vacuum cleaner or wash it with clean water and dry it with a dry cloth.
- When the unit is powered for the first time, the "Bucket Full" light may be lit. Remove and replace the light should go off.

Parts



short screws 13/32"



plastic clips

1. Take the plastic clips out of the accessory bag, and insert them into the holes showed on the attached drawing.

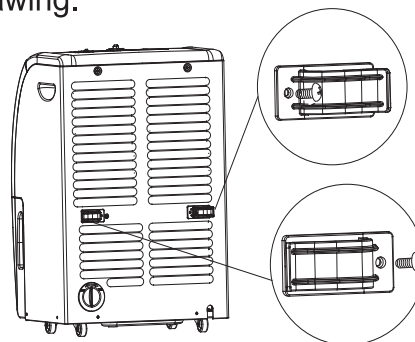
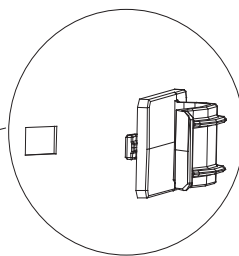
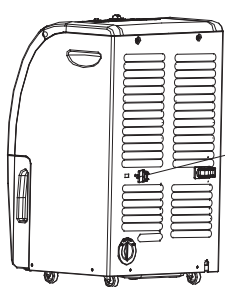

2. Fix them with screw.

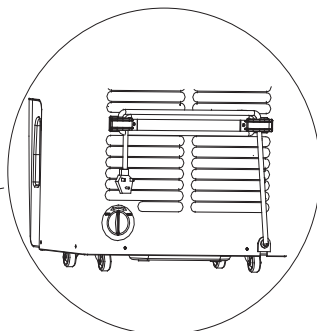
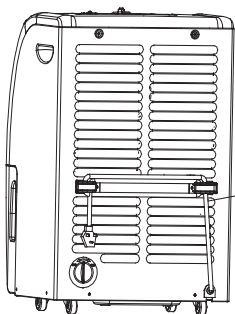

3. The clips can be used for holding the power cord when the unit do not serve or being moved.

If your Dehumidifier does not work as expected

Before calling read the following section first.

It will help you solve the most common problems that might occur and which can be easily corrected.

If all efforts fail and you need service, a toll free number is available please use it to contact our customer service.

Items to check before calling for service:

Unit not operating

- Make sure the plug is pushed completely into the outlet.
- The fuse is blown or circuit was tripped. Check the house fuse/circuit breaker. Replace fuse or reset circuit breaker.
- The bucket is full. The dehumidifier automatically turns off when this occurs. The drain bucket needs to be emptied.

Dehumidifier is icing up during initial stage of operation

- This is normal. Frost will usually disappear within 60 minutes unless temperature is below 60°F. This is normal for the dehumidifier.

Airflow is restricted

- Make sure there are no curtains, blinds or furniture blocking the front or back of the dehumidifier.
- Clean the filter.

Additional note: After prolonged usage, the condenser coils behind the filter may develop a buildup of residual. Unless cleaned regularly with a soft brush, this residual will harden through time and may require special cleaning methods by a refrigeration/air-conditioning serviceman.

Unsatisfactory dehumidification

When first installed, allow at least 3 or 4 days to remove the moisture from the room to maintain the desired dryness.

- Area to be humidified is too large. Check with dealer that model is suitable for room size and moisture level.
- The controls may not be set correctly. Adjust controls according to instructions.
- Doors and windows may not be closed. Check that all doors, windows and other openings are closed tightly and bot open.
- Clothes dryer may be in operation in the same room. Install the dehumidifier away from the moisture-laden air generated by the dryer. Dryer should be vented to the outside.
- Room temperature too low. The unit will not operate satisfactorily if the room temperature is below 60°F.

Warranty Information

FULL ONE YEAR

Warrantor warrants this product against defect in material or workmanship for a period of one year from date of original purchase by a consumer for home use and includes parts and labor required to repair or replace defective parts.

LIMITED FIVE YEAR WARRANTY

For an additional four year period beyond the first year of the general coverage, warrantor will repair or replace at its option any part of the refrigeration system (i.e. COMPRESSOR, EVAPORATOR, CONDENSER OR CONNECTING TUBE) which has failed as a result of defective material or workmanship. Labor required for such repair or replacement is not covered by this warranty.

EXCLUSIONS

WARRANTOR IS NOT RESPONSIBLE FOR CONSEQUENTIAL DAMAGES or damages to product caused by improper power supply voltage, accident, fire, floods or acts of god. Some states do not allow the exclusion or limitation of incidental or consequential damages, so the above limitation or exclusion may not apply to you. This warranty gives you specific legal rights, and you may also have other rights which vary from state to state. To know what you legal rights are in your state, consult your local or state consumer affairs office or your state's Attorney General.

Warrantor:
Haier America Trading L.L.C.
New York, NY 10018

For Toll free service call:
1-877-337-3639.

Model	HD306	HD458	HD658
Refrigerant	R22	R22	R22
Features			
Dehumidification	✓	✓	✓
Automatic Humidistat Control	✓	✓	✓
Automatic shut-off	✓	✓	✓
2 speed fan	✓	✓	✓
Technical data			
Voltage / frequency (V/Hz)	115/60	115/60	115/60
Capacity (pints per 24 hours)	30 pints	45 pints	65 pints
Net dimension WxHxD (inch.)	14 ³ / ₈ x 22 ¹ / ₄ x 13 ³ / ₈	14 ³ / ₈ x 22 ¹ / ₄ x 13 ³ / ₈	14 ³ / ₈ x 22 ¹ / ₄ x 13 ³ / ₈
Packed dimension WxHxD (inch.)	16 ⁵ / ₃₂ x 25 ³ / ₁₆ x 15 ¹ / ₃₂	16 ⁵ / ₃₂ x 25 ³ / ₁₆ x 15 ¹ / ₃₂	16 ⁵ / ₃₂ x 25 ³ / ₁₆ x 15 ¹ / ₃₂
Net weight (lbs.)	37.5	40.8	43.2
Gross weight (lbs.)	41.9	45.2	47.6