

COMPACT DEHUMIDIFIER

home™
homelabs.com

250 ml

HME020018N

Before using your Compact Dehumidifier, please read this manual.

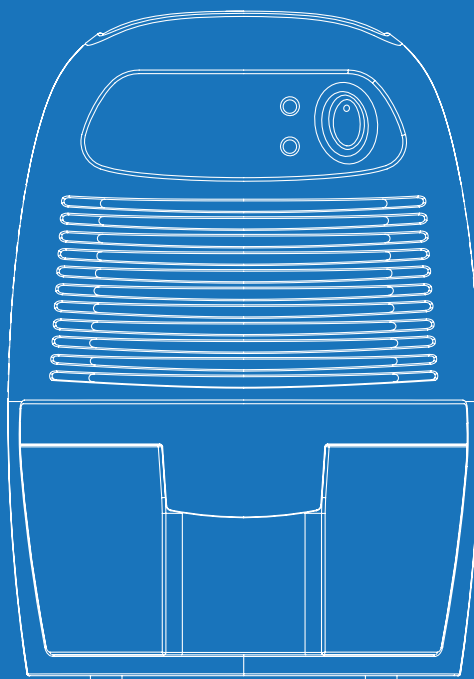

BEFORE FIRST USE:

To prevent any internal damage, it is very important to keep refrigeration units (like this one) upright throughout their journey. Please leave it standing upright and outside the box for **24 HOURS** before plugging it in.

TABLE OF CONTENTS

Important Safeguards	5
Getting to know your Dehumidifier	6
Specifications	7
How to use	7
Removable Water Tank	8
Cleaning	8
Troubleshooting	9
Warranty	10
Warning	11
Contact Us	11

Congratulations

on bringing home your new appliance!

Don't forget to register your product at homelabs.com/reg for updates, coupons, and other relevant information.

Although greatly appreciated, product registration is not required to activate any warranty.

Important Safeguards

SAVE THESE INSTRUCTIONS / FOR HOUSEHOLD USE ONLY

When using your home™ Compact Dehumidifier (appliance), basic safety precautions should always be followed to reduce the risk of fire, electrical shock, and/or injury to persons. Incorrect operation due to ignoring instructions may cause harm or damage.

DANGER

CAUTIONS

1. Switch the compact dehumidifier off by pressing the "On/Off" button to "Off" position when the compact dehumidifier is not in use.
2. Do not use the power adapter in a wet or damp place. Always use the power adapter in an environment with good ventilation.
3. Do not block the front inlet grill or the top outlet.
4. If the appliance is properly connected, but does not receive power, please contact home™ customer service at 1.800.898.3002.
5. Always keep the appliance at an upright position to avoid water leakage.
6. The Compact Dehumidifier should not be operated for an extended amount of time. Use a timer to automatically turn on/off the appliance every 12 hours to prolong the lifespan of the appliance.

Getting to know your Dehumidifier

The Compact Dehumidifier uses Peltier technology (no compressor), making it light and quiet. It is perfect for small rooms because poor ventilation causes musty odors and fungus. The compact dehumidifier aims to lower the humidity of small rooms.

- | | |
|--------------------------|--|
| (1) On/Off button | (8) Rubber feet |
| (2) "On" Green LED | (9) AC/DC switching mode power supply |
| (3) "Full" Yellow LED | (10) DC power jack |
| (4) Air inlet | (11) AC plug with power cord. Plug type may change depending on model. |
| (5) Removable water tank | (12) Water displacement hole |
| (6) Dry air outlet | (13) Water tank |
| (7) DC power socket | (14) Float switch |

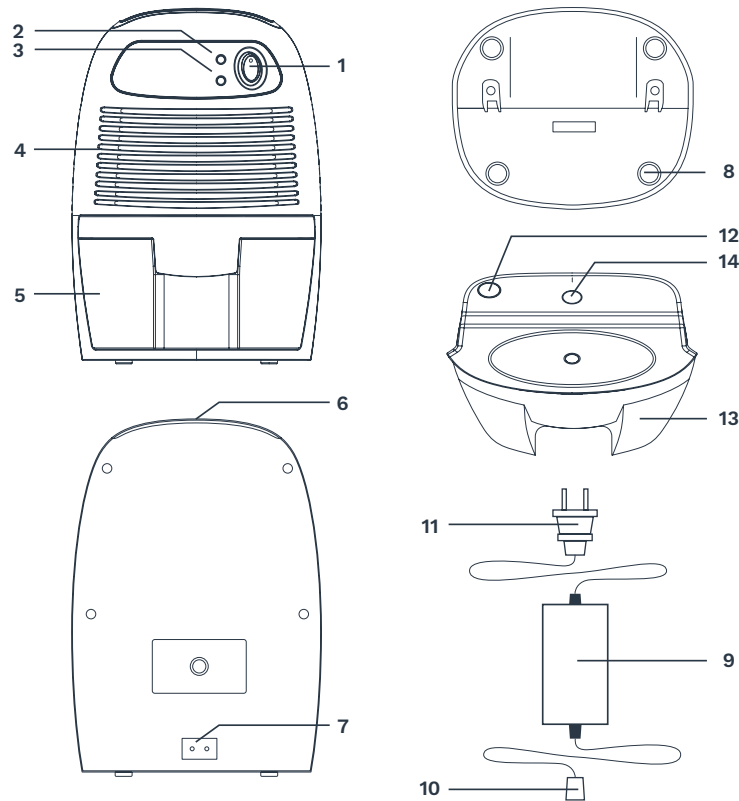

- To avoid electric shock, do not open the appliance.

6

Specifications

Capacity : Approximately 250ml per day at 30°C, 80%RH

Cooling Element : Thermo-electric Peltier module

Fan : 3.15 in x 3.15 in (80mm x 80mm) DC brushless motor

Power Adapter : 9V DC 2.5Amp

Power Consumption : 22.5W

Removable Water Tank : 500ml (16.9 oz)

Water Level Detector : Automatic switch off with "Yellow" LED Indicator when water tank is full

Drying Feature : Warm air outlet on top for drying purposes

Product Dimension : 6.10in (155mm) W x 8.66in (220mm) H x 5.11in (130mm) D

Working Environment : Over 59°F (15°C), over 40%RH

How to use

- Open box and remove packaging material. Box contains:
 - Compact Dehumidifier
 - AC/DC Power Adapter
- Plug the DC power jack of AC/DC power adapter to the DC Power socket, then connect the AC plug of the AC/DC power adapter to the appropriate main socket.
- Switch the "On/Off" button to the "On" position. The green LED will be turned on. The Compact Dehumidifier will begin to operate. You should be able to feel the air blowing from dry air outlet [Fig.1]
- To switch off the appliance, switch "On/Off" button to "Off" position. The Compact Dehumidifier will be turned off. [Fig.2]

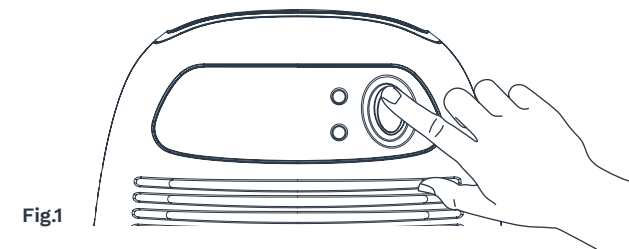

Fig.1

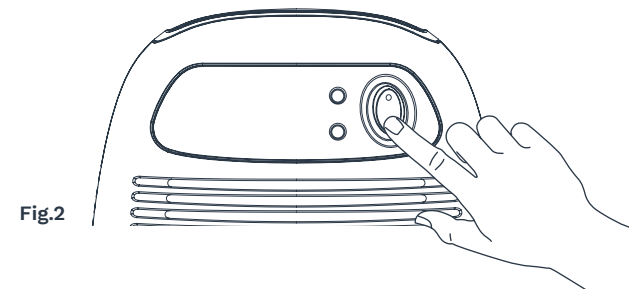

Fig.2

7

Removable Water Tank

When the water tank is full (approximately 500ml [16.9oz] of water collected), the appliance will switch off automatically and the “FULL” LED will be on. [Fig.3]

To remove the water tank, first switch off the Compact Dehumidifier, press “On/Off” button to the “Off” position. Then, remove the water tank from the appliance and pour the water out into the toilet or bathroom sink. Put the water tank back into the appliance. To continue dehumidifying, push the “On/Off” button to “On” position again.

Fig.3

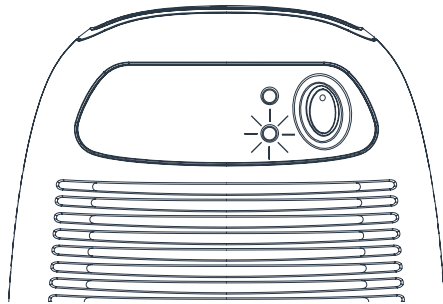

Cleaning

Before cleaning the appliance, turn off the Compact Dehumidifier and unplug the AC plug from the main socket first. Use a piece of soft cloth to clean the surface of the appliance or use a brush to wipe the dust off the grills of the air inlet. You should clear the dry air outlet once a week for optimal performance [as Fig.4].

Fig.4

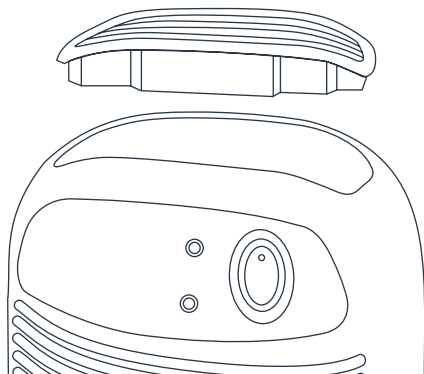

Troubleshooting

PROBLEM	POSSIBLE CAUSE	SOLUTION
Appliance does not work properly.	No Power to appliance.	Connect plug to power socket. Check fuse and wires in the plug. Check the lead is inserted fully into the back of the appliance.
	Switch not turned on.	Switch on (both on the appliance and on the wall socket).
	Tank is not properly inserted to press the internal switches on.	Pull tank out and manually test internal switches to see if appliance powers up. Carefully push tank back in.
	Switch not turned on.	Pour the water out.
Appliance collects little water.	Air inlet vent is blocked.	Remove obstacles.
	Doors and windows are open.	Seal room from external areas.
Water leaks down the front of the appliance.	Extreme temperature changes during brief cold snaps or heatwaves.	Peltier type dehumidifiers work best within a specific temperature range. Unusually extreme weather will affect the level of performance.
	The appliance is on an uneven surface and leaning forward, so water drips out of the front instead of into the tank.	Place the appliance on an even level surface.

Warranty

home™ offers a limited two-year warranty (“warranty period”) on all of our products purchased new and unused from hOme Technologies, LLC, or an authorized reseller, with an original proof of purchase and where a defect has arisen, wholly or substantially, as a result of faulty manufacture, parts, or workmanship during the warranty period. The warranty does not apply where damage is caused by other factors, including without limitation: (a) normal wear and tear; (b) abuse, mishandling, accident, or failure to follow operating instructions; (c) exposure to liquid or infiltration of foreign particles; (d) servicing or modifications of the product other than by home™; (e) commercial or non-household use.

The home™ warranty covers all costs related to restoring the proven defective product through repair or replacement of any defective part and necessary labor, so that it conforms to its original specifications. A replacement product may be provided instead of repairing a defective product. Home™’s exclusive obligation under this warranty is limited to such repair or replacement.

A receipt indicating the purchase date is required for any claim, so please keep all receipts in a safe place. We recommend that you register your product on our website, homelabs.com/reg. Although greatly appreciated, the product registration is not required to activate any warranty and product registration does not eliminate the need for the original proof of purchase.

The warranty becomes void if attempts at repair are made by non-authorized third parties and/or if spare parts, other than those provided by home™, are used.

You may also arrange for service after the warranty expires at an additional cost.

These are our general terms for warranty service, but we always urge our customers to reach out to us with any issue, regardless of warranty terms. If you have an issue with a home™ product, please contact us at 1-800-898-3002, and we will do our best to resolve it for you.

This warranty gives you specific legal rights and you may have other legal rights, which vary from state to state, country to country, or province to province. The customer may assert any such rights at their sole discretion.

Warning

Keep all plastic bags away from children.

State of California Proposition 65 Warnings:

THIS PRODUCT COULD CONTAIN ONE OR MORE CHEMICALS, WHICH ARE KNOWN TO THE STATE OF CALIFORNIA TO CAUSE CANCER, BIRTH DEFECTS, OR OTHER REPRODUCTIVE HARM.

Manufacturer, distributor, importer, and seller are not liable for ANY damage caused by improper use, storage, care, or failure to follow warnings associated with this product.

Contact Us

 CHAT WITH US

homelabs.com/chat

 Call US

1-(800)-898-3002

 EMAIL US

help@homelabs.com



For Household
Use Only

1-800-898-3002
help@homelabs.com
homelabs.com/help

© 2018 hOmeLabs LLC
37 East 18 Street, 7th Floor
New York, NY 10003

All rights reserved. hOme™. Printed in China.