

HEAT CONTROLLER, INC.

OWNER'S MANUAL

Portable Dehumidifier: BHD-G Series R-410A

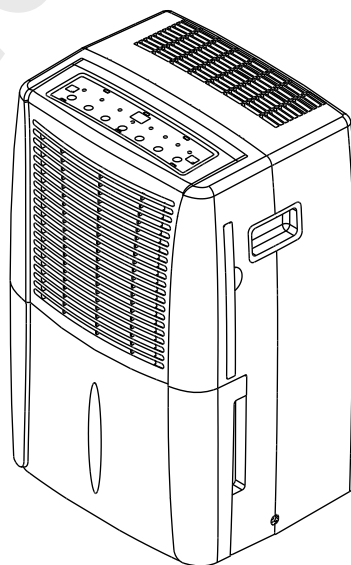

CONTENTS

SAFETY PRECAUTIONS

| | |
|------------------------------|---|
| Warning | 2 |
| Caution | 2 |
| Electrical information | 3 |

CONTROL PANEL

| | |
|---------------------|---|
| Control panel | 4 |
| Other features..... | 5 |

IDENTIFICATION OF PARTS

| | |
|-------------------------------|---|
| Identification of parts | 6 |
| Positioning the unit | 7 |

OPERATING THE UNIT

| | |
|------------------------------------|---|
| When using the unit | 7 |
| Removing the collected water | 8 |

CARE AND MAINTENANCE

| | |
|--|---|
| Care and cleaning the dehumidifier | 9 |
|--|---|



TROUBLESHOOTING TIPS

| | |
|----------------------------|----|
| Troubleshooting tips | 10 |
|----------------------------|----|



SAFETY PRECAUTIONS

To prevent injury to the user or property damage, the following instructions must be followed. Incorrect operation due to ignoring instructions may cause harm or damage.













■ The seriousness is classified by the following indications.

| | |
|--|--|
|  WARNING | This symbol indicates the possibility of death or serious injury. |
|  CAUTION | This symbol indicates the possibility of injury or damage to property. |



■ Meanings of symbols used in this manual are as shown below.

| | |
|---|------------------------|
|  | Never do this. |
|  | Always do this. |

 **WARNING**

| | | |
|--|---|---|
| <p> Do not exceed the rating of the power outlet or connection device.</p> <p>● Otherwise, it may cause electric shock or fire due to excess heat generation.</p> | <p> Do not operate or stop the unit by switching on or off the power.</p> <p>● It may cause electric shock or fire due to heat generation.</p> | <p> Do not use a damaged or unspecified power cord.</p> <p>● It may cause electric shock or fire.</p> |
| <p> Do not modify power cord length or share the outlet with other appliances</p> <p>● It may cause electric shock or fire due to heat generation.</p> | <p> Do not insert or pull out plug with wet hands.</p> <p>● It may cause electric shock.</p> | <p> Do not place the unit near a heat source.</p> <p>● Plastic parts may melt and cause a fire.</p> |
| <p> Disconnect the power if strange sounds, odors or smoke comes from unit.</p> <p>● It may cause fire and electric shock.</p> | <p> You should never try to take apart or repair the unit by yourself.</p> <p>● Always use a certified servicer for repairs</p> | <p> Before cleaning, turn off the power and unplug the unit.</p> <p>● It may cause electrical shock or injury.</p> |
| <p> Do not use the machine near flammable gas or combustibles, such as gasoline, benzene, thinner, etc.</p> <p>● It may cause an explosion or fire.</p> | <p> Do not drink or use the water drained from air conditioner .</p> <p>● It contains contaminants and could make you sick.</p> | <p> Do not open the unit during operation.</p> <p>● It may cause electric shock.</p> |

 **CAUTION**

| | | |
|--|---|---|
| <p> When using in closets or other small spaces, be sure to keep doors open.</p> <p>● Lack of ventilation can cause overheating and fire.</p> | <p> Do not put in places where water may splash onto the unit.</p> <p>● Water may enter the unit and degrade the insulation. It may cause an electric shock or fire.</p> | <p> Place the unit on a level, sturdy section of the floor.</p> <p>● If the unit falls over, it may cause water to spill and damage belongings, or cause electrical shock or fire.</p> |
|--|---|---|

SAFETY PRECAUTIONS

⚠ CAUTION

⊘ Do not obstruct the intake or exhaust openings

- A lack of air flow can lead to overheating and fire.

⌚ Before the unit is cleaned, switch off power and turn off the circuit breaker

- Do not clean unit when power is on as it may cause fire and electric shock, it may cause an injury.

⌚ Always insert the filters securely. Clean filter once every two weeks.

- Operation without filters may cause failure.

⌚ If water enters the unit, turn the unit off and disconnect the power, contact a qualified service technician.

- It may cause failure of appliance or accident.

⊘ Do not place heavy objects on the power cord and take care so that the cord is not compressed.

- There is danger of fire or electric shock.

⊘ Do not use in areas where chemicals are handled.

- This will cause the unit deterioration due to chemicals and solvents dissolved in the air.

⊘ Do not climb up on or sit on the unit.

- You may be injured if you fall or if the unit falls over.

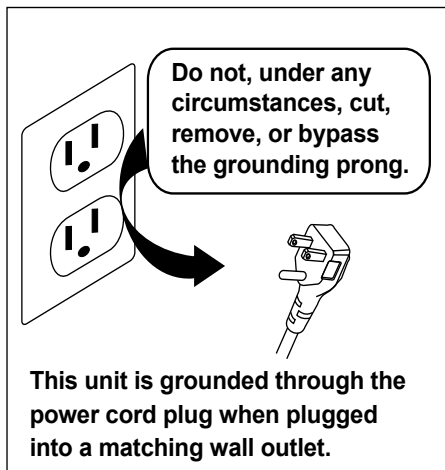

NOTE: The illustration is for explanation purposes only. The actual shape of the plug and wall outlet may be different.

- The manufacturer's nameplate is located on the rear panel of the unit and contains electrical and other technical data specific to this unit.
- Be sure the dehumidifier is properly grounded. To minimize shock and fire hazards, proper grounding is important. The power cord is equipped with a three-prong grounding plug for protection against shock hazards.
- Your dehumidifier must be used in a properly grounded wall receptacle. If the wall receptacle you intend to use is not adequately grounded or protected by a time delay fuse or circuit breaker, have a qualified electrician install the proper receptacle.
- Ensure the receptacle is accessible after the unit installation.
- **Do not use extension cords or an adapter plugs with this unit.** However, if it is necessary to use an extension cord, use an approved air conditioner type extension cord only (available at most local hardware stores).
- To avoid the possibility of personal injury, always disconnect the power supply to the unit, before installing and/or servicing.

CONTROL PANEL

NOTE: The control panel of the unit your purchased may be slightly different according to the specific model. See Fig. 1.

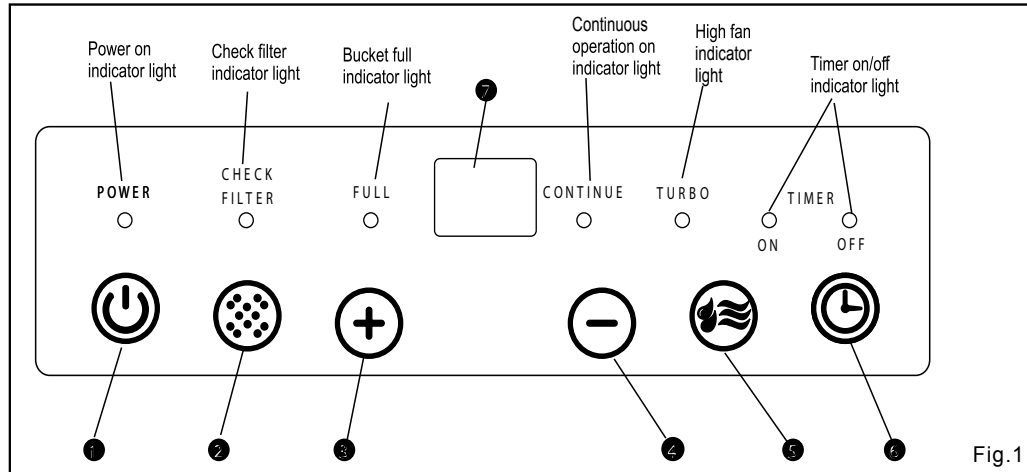

Control Buttons

When you push the button to change operation modes, the unit will make a beep sound to indicate that it is changing modes.

1 POWER

Press to turn the dehumidifier on and off.



2 CHECK FILTER

The check filter feature is a reminder to clean the Air Filter for more efficient operation. The LED light will illuminate after 250 hours of operation. To reset after cleaning the filter, press the CHECK FILTER button and the light will go off.

3 4 : Control Buttons

● Humidity Set Control

The humidity level can be set within a range of 35%RH(Relative Humidity) to 85%RH(Relative Humidity) in 5% increments.

For drier air, press the  pad and set to a lower percent value(%). When the value displays 35%, press the  pad again will activate the continuous dehumidifying operation.

For damper air, press the  pad and set a higher percent value(%).

● TIMER Set Control



Use the Up/Down pads to set the Auto start and Auto stop time from 0.0 to 24 hours.

CONTROL PADS ON THE DEHUMIDIFIER

5 Fan speed

Press to select either High or Normal fan speed. Set the fan control to High for maximum moisture removal. When the humidity has been reduced and quieter operation is preferred, set the fan control to Normal.

6 TIMER

Press to initiate the Auto start and Auto stop feature, in conjunction with the  and  key pads.

7 Display

Shows the set % humidity level from 35% to 85% or auto start/stop time (0~24 hrs.) while programming, then shows the actual (+5% accuracy) room % humidity level in a range of 30% RH (Relative Humidity) to 90% RH when operating.

Error Codes:

AS - Humidity sensor error--Unplug the unit and plug it back in. If error repeats, call for service.

ES - Temperature sensor error-- Unplug the unit and plug it back in. If error repeats, call for service.

P1 - Unit is defrosting-- Allow the unit time to automatically defrost. The error will clear after the unit self defrosts.

P2 - Bucket is full-- Empty the bucket and replace in the right position.

CO - Continuous dehumidification mode is selected.

Other Features

Bucket Full Light

Glows when the bucket is ready to be emptied, or when the bucket is removed or not replaced in the proper position.

Auto Shut Off

The water level control switch shuts off the dehumidifier when the bucket is full, or when the bucket is removed or not replaced in the proper position. When the set humidity level is reached, the unit will be shut off automatically.

Auto Defrost

When frost builds up on the evaporator coils, the compressor will cycle off and the fan will continue to run until the frost disappears.

3 Minute Compressor Time Delay

After the unit has stopped, it can not be restarted within the first 3 minutes. This is to protect the compressor. Operation will automatically start after 3 minutes. If the compressor was interrupted during operation, it can not be stopped in the first 3 minutes unless it is caused by the bucket being full of water, defrosting or power failure modes.

Check filter feature

The system starts to count the time once the fan motor operates. The check filter feature can be only activated when the accumulated operation time achieves 250 hours or more. The CHECK FILTER indicator light flashes at 1Hz. After the air filter has been cleaned, replace it in the unit and press the  button and the CHECK FILTER indicator light goes off.

Power Outage – Auto Restart Feature

In the case of a power outage or interruption, the unit will automatically re-start, in the setting last used, after the power is restored.

Setting the Timer

- When the unit is on, press the Timer button, the TIMER OFF indicator light illuminates. It indicates the Auto Stop program is initiated.
- When the unit is off, press the Timer button, the TIMER ON indicator light illuminates. It indicates the Auto Start program is initiated.
- Press or hold the UP or DOWN buttons to change the time by 0.5 hour increments, up to 10 hours, then at 1 hour increments up to 24 hours. The control will count down the time remaining until start.
- The selected time will register in 5 seconds and the system will automatically revert the display back to the previous humidity setting.
- When the Auto start & Auto stop times are set, within the same program sequence, TIMER ON/OFF indicator lights illuminate identifying both ON and OFF times are now programmed.
- Turning the unit ON or OFF at any time or adjusting the timer setting to 0.0 will cancel the Auto Start/Stop function.
- When the LED display window displays the code for P2, the Auto Start/Stop function will also be cancelled.

IDENTIFICATION OF PARTS

Front

- ① Control panel
- ② Air intake grille
- ③ Air outlet grille
- ④ Handle
- ⑤ Water bucket
- ⑥ Water level window

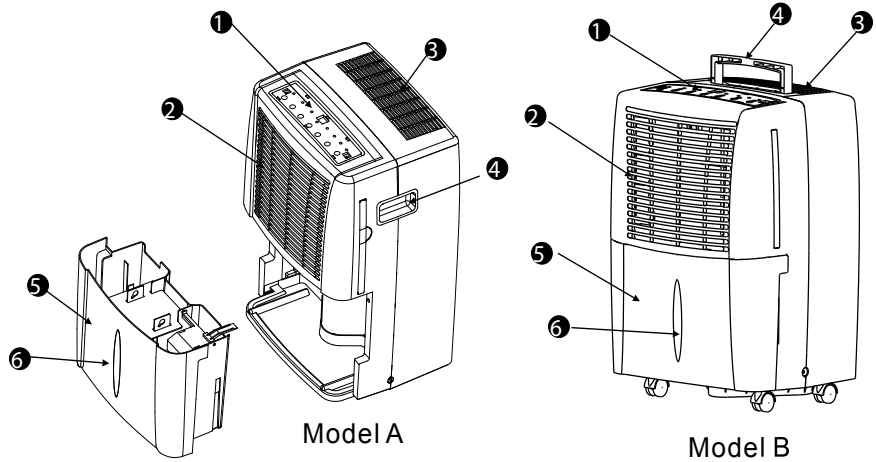

Rear

- ① Air filter
- ② Power cord Band(Used only when storing the unit.)
- ③ Caster
- ④ Power Cord and plug
- ⑤ Drain hose outlet

NOTE: All the pictures in the manual are for explanation purposes only. The actual shape of the unit you purchased may be slightly different, but the operations and functions are the same.

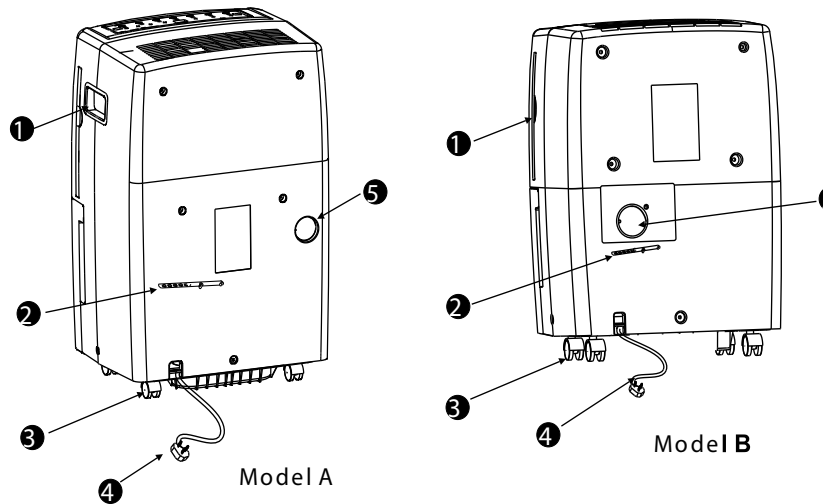

OPERATING THE UNIT

Positioning the unit

- Do not use outdoors.
- This dehumidifier is intended for indoor residential applications only. This dehumidifier should not be used for commercial or industrial applications.
- Place the dehumidifier on a smooth, level floor strong enough to support the unit with a full bucket of water.
- Allow at least 8in. (20cm) of air space on all sides of the unit for good air circulation.
- Place the unit in an area where the temperature will not fall below 41°F (5°C). The coils can become covered with frost at temperatures below 41°F (5°C) which may reduce performance.
- Keep unit away from heat sources, such as clothes dryer, heater or radiator.
- Use the unit to prevent moisture damage anywhere books or valuables are stored.
- Use the dehumidifier in a basement to help prevent moisture damage. **NOTE:** A dehumidifier operating in a basement will have little or no effect in drying and adjacent enclosed storage area, such as a closet, unless there is adequate circulation of air in and out of those additional areas.
- The dehumidifier must be operated in an enclosed area to be most effective.
- Close all doors, windows and other outside openings to the room.

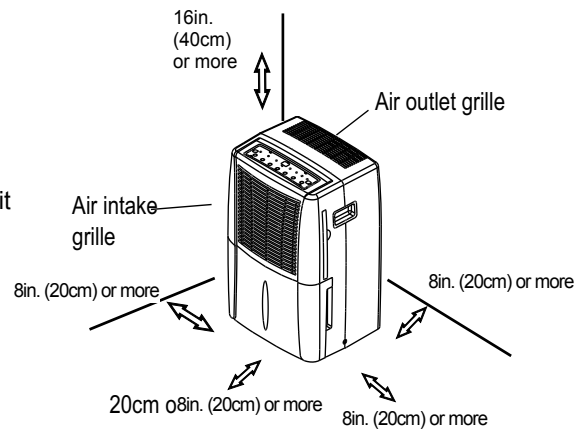

Fig.4a

Casters (At four points on the bottom of unit)

- Casters can move freely.
- Do not force casters to move over carpet, nor move the unit with water in the bucket. (The unit may tip over and spill water.)

When using the unit

NOTE: When removing the dehumidifier from its packaging, you will find tape pasted on several places of the unit (see Fig. 4b). It is for transportation purposes only, just remove tape before using the unit.

- When first using the dehumidifier, operate the unit continuously 24 hours.
- This unit is designed to operate with a working environment between 41°F and 95°F (5°C - 35°C).
- If the unit has been switched off and needs to be switched on again quickly, allow approximately three minutes for the correct operation to resume.
- Do not connect the dehumidifier to a multiple socket outlet, which is also being used for other electrical appliances.
- Select a suitable location, making sure you have easy access to an electrical outlet.
- Plug the unit into a electrical socket-outlet with a ground connection.
- Make sure the Water bucket is correctly installed otherwise the unit will not operate properly.



Fig.4b

OPERATING THE UNIT

Removing the collected water

There are two ways to remove collected water.

1. Use the bucket

- When the bucket is full, the unit will automatically stop running, the unit will beep 8 times and the Full indicator light will flash, the digital display shows P2 .
- Slowly pull out the bucket. Grip the left and right handles securely, and carefully pull out straight so water does not spill. Do not put the tank on the floor because the bottom of the bucket is uneven. Otherwise the bucket will fall and cause the water to spill.
- Throw away the water and replace the bucket. The bucket must be in place and securely seated for the dehumidifier to operate.
- The unit will re-start when the bucket is restored in its correct position.

NOTES:

- When you remove the bucket, do not touch any parts inside of the unit. Doing so may damage the product.
- Be sure to push the bucket gently all the way into the unit. Banging the bucket against anything or failing to push it in securely may cause the unit not to operate.

2. Continuous draining

Water can be automatically emptied into a floor drain by attaching the unit with a water hose ϕ 0.5 in. (ϕ 12mm) (not included).

- Remove the water bucket from the front of the unit, you will find a section of hose located above the bucket.
- Remove the rubber plug from the back of the unit and store it in a safe location (see Fig.8).
- Insert the water hose through the hole in the back of the unit and securely press it onto the connector on the front of the unit (Fig.9). Then lead the water hose to the floor drain or a suitable drainage location.
- Replace the bucket in the unit. The bucket must be in place and securely seated.

NOTE: When the continuous drain feature is not being used, remove the drain hose from the connector and attach the rubber plug back over the drain hole as shown in Fig. 1.

1. Pull out the bucket a little.

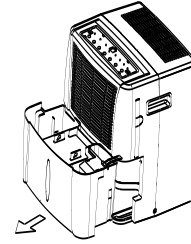

Fig.5

2. Hold both sides of the bucket securely and pull it out from the unit.

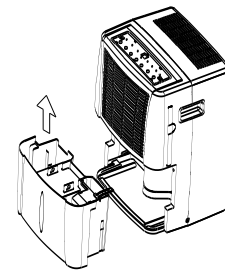

Fig.6

3. Pour the water out.

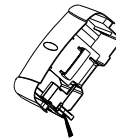

Fig.7

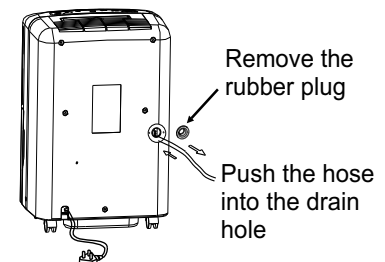

Fig.8

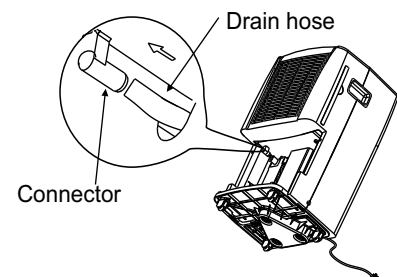

Fig.9

CARE AND MAINTENANCE

Care and cleaning of the dehumidifier

Turn the dehumidifier off and remove the plug from the wall outlet before cleaning.

1. Clean the Grille and Case

- Use water and a mild detergent. Do not use bleach or abrasives.
- Do not splash water directly onto the main unit. Doing so may cause an electrical shock, cause the insulation to deteriorate, or cause the unit to rust.
- The air intake and outlet grilles get soiled easily, so use a vacuum attachment or brush to clean.

2. Clean the bucket

Every few weeks, clean the bucket to prevent growth of mold, mildew and bacteria. Partially fill the bucket with clean water and add a little mild detergent. Swish it around in the bucket, empty and rinse.

NOTE: Do not use a dishwasher to clean the bucket. After cleaning, the bucket must be in place and securely seated for the dehumidifier to operate.

3. Clean the air filter

The air filter behind the front grille should be checked and cleaned at least every 30 days or more often if necessary.

NOTE: DO NOT PUT THE FILTER IN AN AUTOMATIC DISHWASHER.

To remove:

- Grip the tab on the filter and pull it out as shown in Fig.11A.
- Clean the filter with warm, soapy water. Rinse and let the filter dry before replacing it. Do not clean the filter in a dishwasher.

To attach:

Insert the air filter into the unit from the side and push it in. See Fig.11C

CAUTION:

- DO NOT operate the dehumidifier without a filter because dirt and lint will clog it and reduce performance.

4. When not using the unit for long periods of time

- After turning off the unit, wait one day before emptying the bucket.
- Clean the main unit, water bucket and air filter.
- Wrap the cord and bundle it with the band .
- Cover the unit with a plastic bag.
- Store the unit upright in a dry, well-ventilated place.

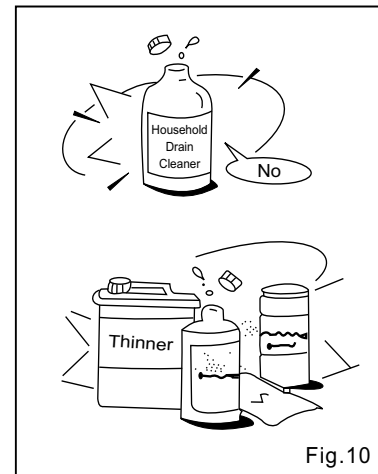

Fig.10

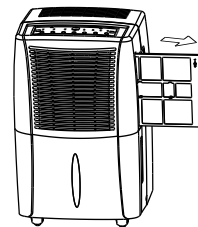

Fig. 11A

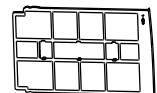

Fig. 11B

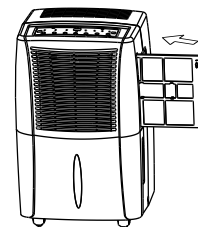

Fig. 11C

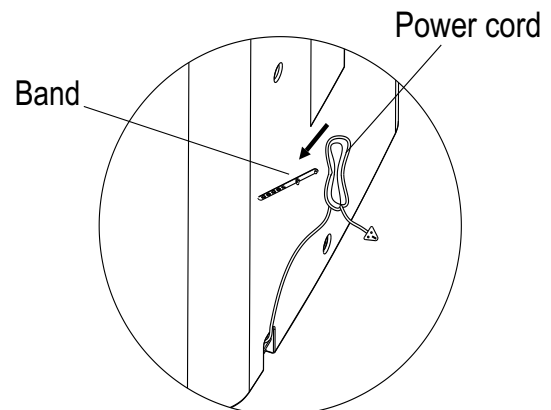

Fig. 12

TROUBLESHOOTING TIPS

Before calling for service, review the charts below first

| Problem | What to check |
|--|---|
| Unit does not start | <ul style="list-style-type: none"> ● Make sure the dehumidifier's plug is pushed completely into the outlet. ● Check the house fuse/circuit breaker box. ● Dehumidifier has reached its preset level or bucket is full. ● Water bucket is not in the proper position. |
| Dehumidifier does not dry the air as it should | <ul style="list-style-type: none"> ● Allow enough time to remove the moisture. ● Make sure there are no curtains, blinds or furniture blocking the front or back of the dehumidifier. ● The humidity control may not be set low enough. ● Check that all doors, windows and other openings are securely closed within the room the unit is operating in. ● Room temperature is too low, below 41°F (5°C). ● There is a kerosene heater or something giving off water vapor in the room. |
| The unit makes a loud noise when operating | <ul style="list-style-type: none"> ● The air filter is clogged. ● The unit is tilted instead of level or upright as it should be. ● The floor surface is not level. |
| Frost appears on the coils | <ul style="list-style-type: none"> ● This is normal. The dehumidifier has Auto defrost feature, which will remove frost as needed . |
| Water on floor | <ul style="list-style-type: none"> ● Hose to connector or hose connection may be loose. ● Intend to use the bucket to collect water, but the back drain plug is removed. |
| ES, AS, P1 or P2 appear in the display | <ul style="list-style-type: none"> ● These are error codes. See the CONTROL PANEL section . |

11/2009