



ENGLISH

中文

# OWNER'S MANUAL DEHUMIDIFIER

Read before using product (safety instruction), use properly.  
About ensuring users safety and property.  
Product warranty card is enclosed with the user manual.  
After careful read through the user manual, do keep it in a handy place.

Models : LD106F\*\*  
LD136F\*\*  
RD136F\*\*



P/NO : MFL68026001

[www.lg.com](http://www.lg.com)

## 2 SAFETY PRECAUTIONS

## SAFETY PRECAUTIONS

The following safety precautions are intended to prevent accidental property damage and personal injury through safe and correct use of the product.

**! WARNING**

Failure to follow the instructions could result in death or serious injury of the user.

**! CAUTION**

Failure to follow the instructions could result in personal injury or property damage.

**! WARNING**When installing the dehumidifier

- **Do not damage, alter, excessively bend, twist, pull, pinch or heat the power cord.**  
If the power cord is damaged, request for repair to the service technician to prevent any risk.  
If not, it can cause fire, electric shock or product failure.
- **Do not use multiple-outlet adaptors with this dehumidifier.**  
Excessive use of power could result in electric shock or fire.
- **Do not use the product if the outlet is damaged or loose.**  
Doing so could result in electric shock or fire.
- **If there is a gas leak, open the window for ventilation before using the dehumidifier.**  
Failure to do this could result in explosion, fire or burns.
- **Do not disassemble, repair or modify the product.**  
Doing so could result in fire or electric shock.
- **Do not store or use flammable gases or materials near the dehumidifier.**  
Doing so could result in fire or product malfunction.
- **This appliance is not intended for use by persons (including children) with reduced physical, sensory or mental capabilities, or lack of experience and knowledge, unless they have been given supervision or instruction concerning use of the appliance by person responsible for their safety.**  
Children should be supervised to ensure that they do not play with the appliance.

When using the dehumidifier

- **Push the power plug all the way into the wall outlet so that it is not loose.**  
A loose connection could result in fire.
- **Do not touch the power plug with wet hands.**  
Doing so could result in electric shock or injury.
- **Do not modify or extend the power cord.**  
Doing so could result in fire or electric shock.
- **If the product makes a strange noise or emits a smell or smoke, pull the power plug out and contact the service center.**  
Failure to do this could result in explosion, fire or burns.
- **Avoid placing the dehumidifier or other heavy objects on top of the power cord.**  
Doing so could result in fire or electric shock.
- **Do not use water to clean the dehumidifier.**  
Doing so could result in electric shock or malfunction.

- **Keep the air inlet and outlet free from obstructions.**  
Failure to do this could result in poor performance or malfunction.
- **Do not cover the power cord with a mat etc.**  
If heavy objects are placed on the mat, the power cord underneath could be damaged, causing fire or electric shock.
- **Do not place combustion appliances directly in the path of the dehumidifier's airway.**  
Doing so could result in incomplete combustion or deformation by heat.
- **Keep the product away from fire.**  
Failure to do this could result in fire.
- **Do not use the product in places where it could be splashed by water.**  
Doing so could result in fire or electric shock.
- **Do not insert fingers, sticks etc. into the air inlet or outlet.**  
You could be injured by the high-speed fan.
- **Only qualified personnel may clean the internal parts. Do not use corrosive detergents.**  
Doing so could result in product malfunction, fire or electric shock.

## CAUTION

### When installing the dehumidifier

- **Do not use the product for purposes other than its intended use.**  
This product is not designed for preserving precision instruments, tableware or art works. The quality of the items you are trying to preserve could deteriorate.
- **Ventilate frequently.**  
Keep the area well ventilated, especially if you are using a combustion appliance as well. Inadequate ventilation reduces the oxygen level in the air.
- **Always hold the plug head when pulling the power plug.**  
Failure to do so could result in electric shock or injury.
- **Do not use excessive force when pulling the extension hose.**  
Doing so could result in damage to or deformation of the hose.
- **Do not use the product in places where chemicals are used.**  
Chemicals and solvents dissolved in the air in places such as hospitals, factories, laboratories and hair salons could cause the product to become deformed, causing the dehumidified water to leak and wet nearby household items, equipment etc.
- **Turn off the dehumidifier and pull out the power plug before cleaning.**  
If you do not do this, you could be injured by the high-speed fan.
- **DO NOT operate the dehumidifier without a filter.**  
Using the product without a filter could result in a reduced product lifespan, electric shock or injury. 10 cm or longer

### When using the dehumidifier

- **Do not use the product for preserving animals/plants, precision instruments, art works etc.**  
You could be injured due to falling etc.
- **Do not place vases or water jars on the dehumidifier.**  
If the water flows into the dehumidifier, it could result in fire or electric shock.

#### 4 SAFETY PRECAUTIONS

- **Turn off the dehumidifier and empty the water tank before moving the dehumidifier.**  
The water could overflow from the tank, wetting household items or causing fire or electric shock.
- **Pull out the power plug if you will not be using the product for an extended period.**  
Failure to do this could result in product malfunction or fire.
- **Do not use the product in a very small space such as a closet.**  
Poor ventilation could result in overheating or fire.
- **Do not use wax, thinner or a strong detergent when cleaning. Wipe the product using a soft cloth.**  
Using inappropriate cleaning products could cause the product to become discolored or develop surface flaws.
- **Do not use the product in direct sunlight or rain.**  
The product could overheat, causing fire or electric shock.
- **Do not touch the product with wet hands.**  
Doing so could result in electric shock. Position the product on a firm, stable surface.
- **If the product is on an unstable surface, it may vibrate and make noise.**  
If the product is tilted or laid down, the dehumidified water could overflow and the product could malfunction.
- **Do not keep the power cord tied up when using the product.**  
The power cord could overheat, resulting in fire.
- **Do not spray foreign substances or water into the sensor hole.**  
This could result in electric shock or malfunction.
- **Do not use the product at unstable voltage for a long period of time.**  
The product may stop automatically to protect itself. This could result in electric shock or malfunction.

# TABLE OF CONTENTS

<b>2</b>	<b>SAFETY PRECAUTIONS</b>	<b>22</b>	<b>TROUBLESHOOTING TIPS</b>
<b>6</b>	<b>QUICK START</b>		
<b>7</b>	<b>PARTS</b>		
8	Control Panel		
9	Display Panel		
<b>10</b>	<b>BEFORE USING THE PRODUCT</b>		
<b>11</b>	<b>USING THE DEHUMIDIFIER</b>		
12	Auto dehumidifying		
13	Air purifying		
14	Shoe Dry		
15	Auto Defrost		
15	Timer		
16	Water Full		
17	Humidity Setting		
17	Lock Control		
18	Drainage		
19	Cleaning the dehumidifier		
21	Storing the dehumidifier		

6 QUICK START

## QUICK START

### Dehumidifier efficiency varies depending on room temperature and relative humidity

- A lower temperature and lower relative humidity will reduce the moisture removal rate.
- The compressor operates in dehumidification mode only when the set humidity is lower than the room humidity.

### The operating temperature is 5°C to 32°C.

- The dehumidifier cannot be used at 1°C or below because the dehumidified water could freeze.
- At 32°C or higher, the dehumidifier may stop running automatically to protect itself from over-heating.

### The room temperature increases while the dehumidifier is running.

- This dehumidifier does not have temperature control functions.
- The dehumidifier generates heat while operating, raising the room temperature by about 2°C or 3°C depending on the usage conditions (room air pressure and room size).

### The dehumidifier can be restarted after three minutes.

- If you attempt to restart the dehumidifier immediately after stopping it, the compressor will start running again after about three minutes for product safety reasons.

# PARTS

## Front

- 1. ON/OFF Button
- 2. Air outlet
- 3. Water tank handle
- 4. Water tank
- 5. Display panel
- 6. Louver
- 7. Sensor : Must not be obstructed.
- 8. Water tank lid

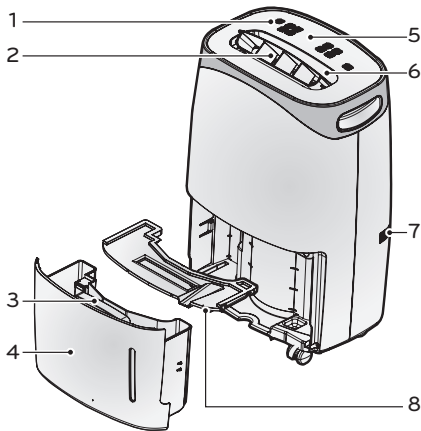

## Rear

- 1. Antibacterial filter
- 2. Air inlet : The surrounding air and moisture enter through this inlet.
- 3. Roller
- 4. Extension hose cover
- 5. Multi Protection Filter(Optional): Included in the box with the product. Please assemble before using it.
- 6. Power cord
- 7. Power cord hanger

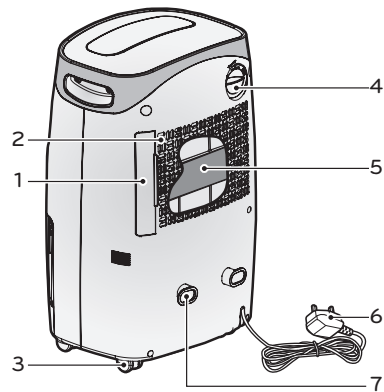

## 8 PARTS

## Control Panel

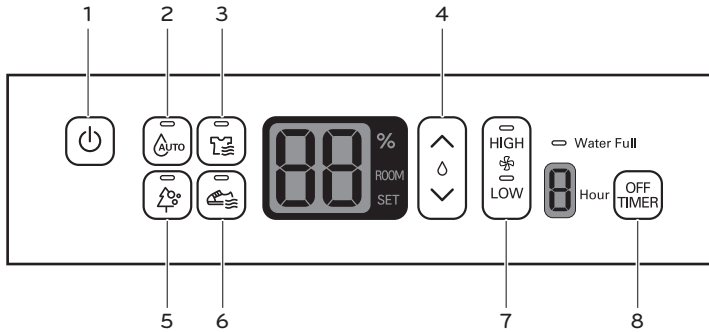

1. ON/OFF Button : Used to start and stop the product.
2. Auto Dehumidifying Button: Automatically dehumidifies and cleans the air while maintaining set humidity.
3. Laundry Dry Button: Used for drying laundry or dehumidifying the air regardless of the current room humidity.
4. Humidity Setting Button: Used to adjust the set humidity level. (30%–70%)
5. Air Purifying Button: Used to clean the air without dehumidifying.
6. Shoe Dry Button: Used for intensive drying of shoes, bags etc.  
(Connect the extension hose. If necessary, attach the shoe dry hose to the extension hose.)
7. Air Volume control Button: Used to adjust the air volume.
8. Timer Button: The product stops running after the set time.  
The timer is extended by one hour each time the button is pressed, up to eight hours.



## Display Panel

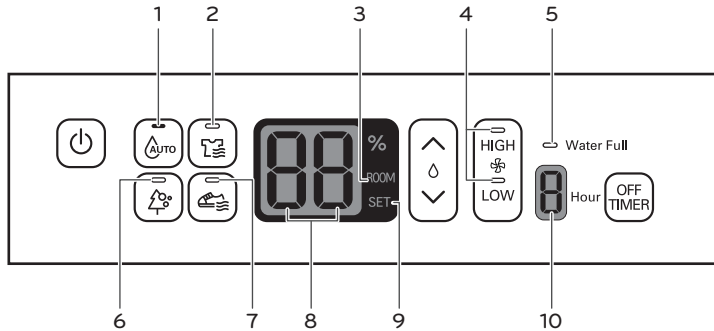

1. Auto Dehumidifying Indicating Lamp
2. Laundry Dry Indicating Lamp
3. Room Humidity Indicating Lamp : The humidity display shows the room humidity.
4. Air Volume Indicating Lamp : Shows the current air volume.
5. Water Full Indicating Lamp : The indicator light is red when the water tank is full.
6. Air Purifying Indicating Lamp
7. Shoe Dry Indicating Lamp
8. Humidity Indicating Lamp
9. Set Humidity Indicating Lamp : The humidity display shows the setting humidity
10. Timer Indicating Lamp

### About Condensation

Condensation refers to the formation of dew on windows, ceilings etc. at low temperatures and high humidity.

#### • Using the product for the first time

Some water may remain in the water tank from the product inspection process at the factory. This is normal

#### • When emptying the water

- Pull the water tank carefully with both hands. The water could overflow if you pull the water tank with excessive force.

- Remove the water tank only when the dehumidifier is not operating or when the Tank Full indicator is lit. If the water tank is removed while the dehumidifier is running, the compressor stops, the fan continues to run for about three minutes to evaporate the residual condensate in the heat ex-

changer and then the Tank Full indicator lights up and the dehumidifier stops.

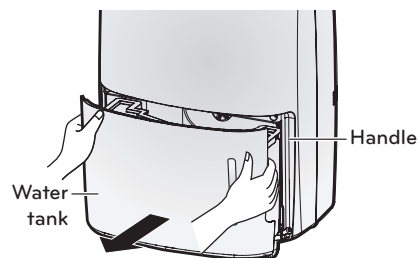

## BEFORE USING THE PRODUCT

### Use the product at temperatures of 5°C to 32°C.

- The dehumidifier cannot be used at 1°C or below because the dehumidified water could freeze.
- At 32°C or higher, the compressor may stop running automatically to protect itself from overheating.

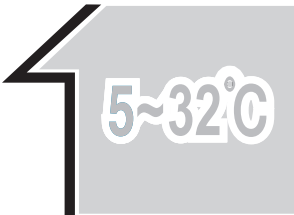

### Pull the power plug out of the wall outlet if you will not be using the product for a long period of time.

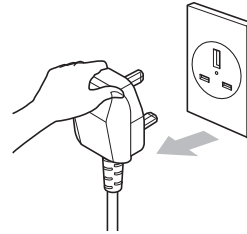

### Keep the product at least 30 cm away from walls etc.

- Poor ventilation results in lower dehumidifier efficiency.

### Wait three minutes before restarting

If you restart the dehumidifier immediately after stopping it, the dehumidifier starts running about three minutes later to protect the compressor.

- The dehumidifier makes a noise for the first second or two of operation as the compressor starts running.
- If the room humidity is lower than the set humidity in Auto Dehumidifying mode or if you are using Air purifying mode, the dehumidifier is quiet because the compressor is not running.

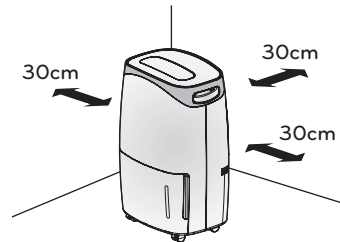

### The room temperature can increase by about 2 to 3°C while the dehumidifier is running.

This dehumidifier does not include air-conditioning functions. In fact, it generates heat while running.

## USING THE DEHUMIDIFIER

### Find the Multi Protection Filter(Optional) in the product box and attach it to the antibacterial filter.

- The 3M markings must be visible when the filter is attached.
- The Multi Protection Filter collects various substances that cause respiratory diseases and allergies and removes harmful germs from the air.

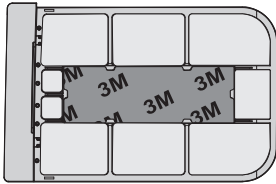

### Insert the power plug into the wall outlet.

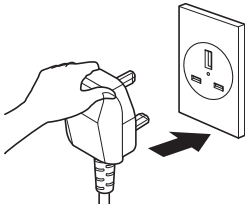

### Press the ON/OFF button.

- The louver opens and the product starts in Auto dehumidifying mode. If no buttons are pressed, the Set Humidity is set to 50% after the first 30 minutes of operation.

\* The humidity display shows the room humidity.

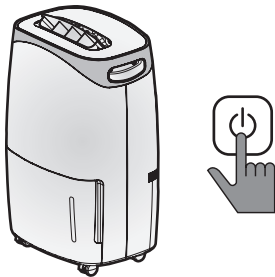

Select an operation mode using the Auto dehumidifying, Laundry dry, Air purifying or Shoe dry button.

- The selected mode is indicated by the indicating lamp. Control Air volume. (When the operator mode changes, the air volume is automatically set to High.)

Press the ON/OFF button again to stop the dehumidifier.

- The louver closes.
- All lamps turn off and the dehumidifier stops.

### CAUTION

If you attempt to restart the product immediately after stopping it, it will not start running for about three minutes in order to protect the compressor.

## 12 USING THE DEHUMIDIFIER

**Auto dehumidifying****To maintain optimal comfort**

- The dehumidifier maintains the set humidity.
- The compressor runs in dehumidifying mode only when the set humidity is lower than the room humidity. (Dehumidification starts again when the room humidity increases.)

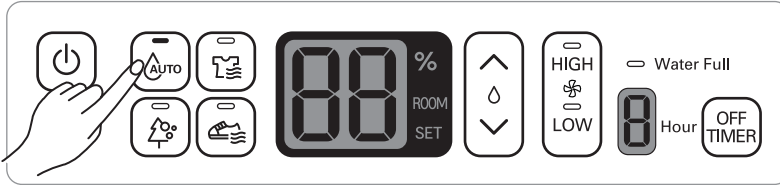

**Adjust the set humidity level by pressing the  $\wedge$  /  $\vee$  Humidity Setting buttons.**

- 30  $\leftrightarrow$  35  $\leftrightarrow$  40  $\leftrightarrow$  45  $\leftrightarrow$  50  $\leftrightarrow$  55  $\leftrightarrow$  60  $\leftrightarrow$  65  $\leftrightarrow$  70
- When you adjust the humidity level, the Set humidity is shown on the humidity display for about five seconds and then the room humidity is displayed.

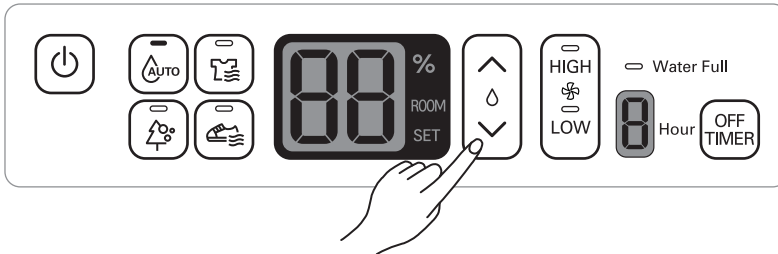
**Laundry dry****To dry laundry etc. continuously, regardless of the room humidity level**

- Set humidity level selection is not available in Laundry dry mode.

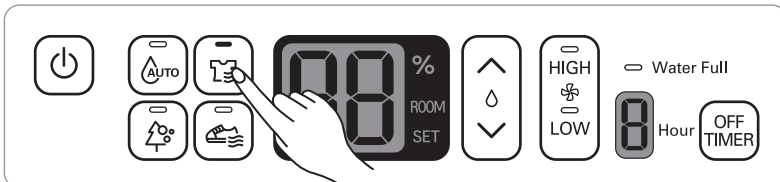

When you press the Laundry dry button, the Laundry dry Indicating Lamp lights up.

The louver moves up and down in Laundry dry mode.

Ensure that water does not drip from the laundry onto the dehumidifier.

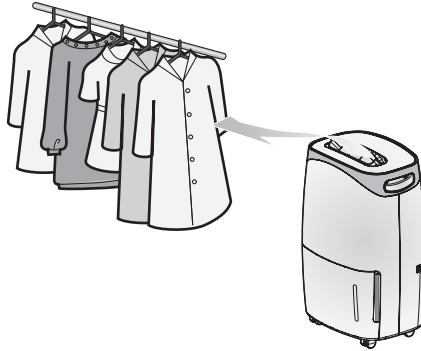

### Air purifying

#### To keep the air clean

- This mode removes dust, from the air. Dehumidification is not enabled in this mode.
- Set humidity level selection is not available in Air purifying mode.

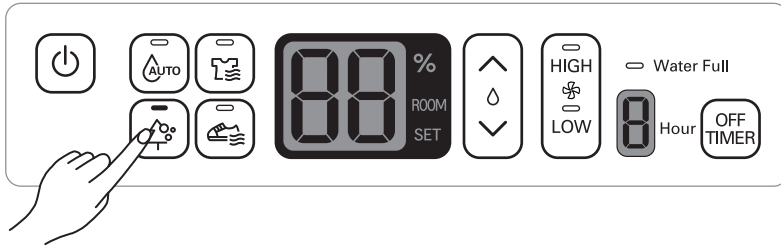

14 USING THE DEHUMIDIFIER

### Shoe Dry

**For intensive drying of shoes, bags etc.**

- Connect the extension hose.
- If necessary, connect the Shoe dry hose to the extension hose.
- Set humidity level selection is not available in shoe dry mode.

**Open the hose cover.**

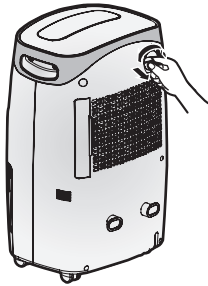

**Connect the extension provided with the product.**

- Insert the hose by aligning the hose slot with the ▼ marking on the dehumidifier and turn the hose counterclockwise.
- You may attach the shoe dry hose to the extension hose.
- Align the shoe dry hose slot with the ▲ marking on the extension hose and position it in the required direction.

\* Accessories are contained in the top portion of the product box.

extension hose



shoe dry hose

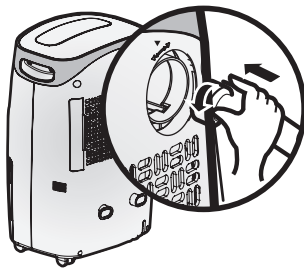

**Extend the hose and position it in the desired direction.**

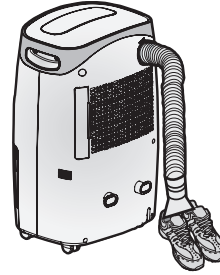

**When you press the Shoe Dry button, the Shoe Dry indicator lights up.**

- Dehumidified dry air is released from the hose.

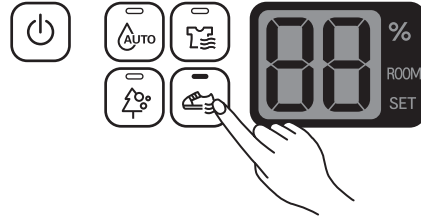

**CAUTION**

- Do not move the dehumidifier by pulling the extension hose. The dehumidifier could fall and cause injury.
- The dehumidifier may stop to protect itself if you use Shoe Dry mode for a long period of time.

### Auto Defrost

If frost forms on the heat exchanger due to low room temperature, the dehumidifier automatically removes the frost.

- When 'dF' is shown on the display panel during operation, the product automatically defrosts the built-in heat exchanger.

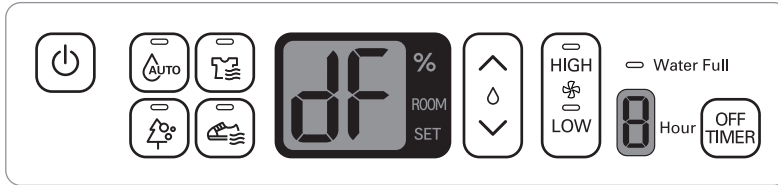

### Timer

**Check that the dehumidifier is running.  
Press the Timer button.**

- Set the timer using the Timer selection cycle below.  
(One-hour intervals) → 1 → 2 → ... → 8 → no display
- The display shows the number of hours remaining on the timer as time passes.
- The dehumidifier stops running when the timer ends.

### Canceling Timer

- To cancel the Timer function, press the Timer button until nothing is shown on the Timer display.

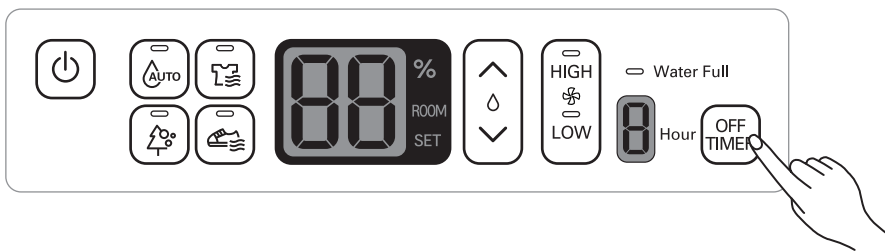

**Empty the water tank before setting the time.**

- If the tank becomes full while the dehumidifier is running with Timer enabled, the Water Full indicating Lamp lights up and the product stops running in Dehumidifying mode.

## 16 USING THE DEHUMIDIFIER

**Water Full**

When the water tank is full, the dehumidifier stops running automatically. The Water Full indicating Lamp lights up and the alarm tone sounds three times.

- When the water tank is full, dehumidification stops immediately. The fan continues to run for three minutes to remove the residual condensate, and then the Water Full indicating Lamp lights up and the product stops running
- Empty the water tank and reinsert it. The Water Full indicator turns off and the dehumidifier starts running again automatically.

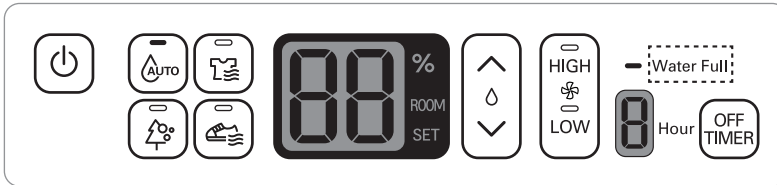
**When emptying the water tank**

- Pull the water tank gently.
- The water could overflow if you pull the water tank with excessive force.
- Always stop the dehumidifier when removing the water tank.
- If the water tank is removed, the compressor stops, the fan continues to run for about three minutes to evaporate the residual condensate in the heat exchanger and then the dehumidifier stops completely.

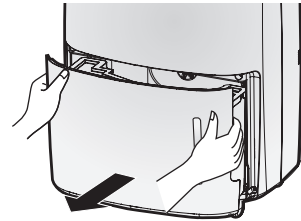
**Using the product for the first time**

- Some water may remain in the drain water tank from the product inspection process at the factory. This is normal.

**CAUTION**

- The Water Full indicating Lamp may also light up when the product is moved or suffers an impact.
- Empty the water tank and reinsert it.



## Humidity Setting

Used to maintain the room humidity at a set level.

**Check that the dehumidifier is running.  
Press the Humidity Setting buttons.**

- Press the Humidity Setting buttons (  $\wedge$  /  $\vee$  ) to adjust the Set humidity level.

**The product stops running in Dehumidifying mode when the set humidity is lower than the room humidity.**

\* Humidity Setting is not available in Laundry dry, Shoe dry or Air purifying mode.

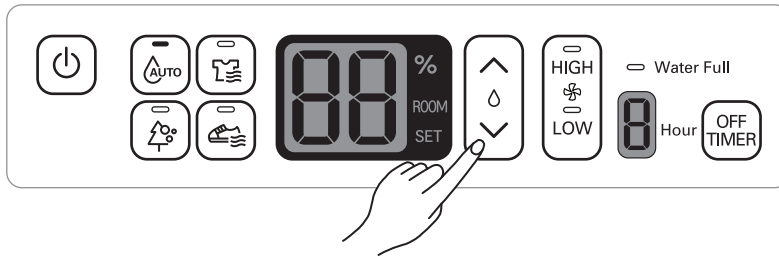

The room humidity is displayed to the nearest 5%.

## Lock Control

**Press and hold the High Air volume button and the  $\wedge$  button simultaneously for three seconds.**

- When you hear a beep after three seconds, release the buttons to lock the control panel.
- "CL" flashes three times on the display panel.
- When the control panel is locked, the dehumidifier remains in the current operation mode. The operation will not be affected by any of the buttons until the control panel is unlocked.
- When a button is pressed, an alarm tone is generated and "CL" flashes three times on the display panel.
- The control panel can be locked even if the dehumidifier is not running.

**To unlock the control panel**

- Press and hold the High Speed button and the  $\wedge$  button simultaneously for three seconds.
- When you hear a beep after three seconds, release the buttons to unlock the control panel.

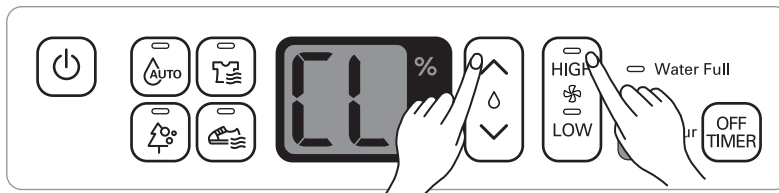

## Drainage

### Remove the water tank.

- Pull the water tank gently, using both hands to hold the handles on both sides.
- Be careful not to spill the water if the tank is full.



### CAUTION

- Always stop the dehumidifier when removing the water tank.
- If the water tank is removed, the compressor stops, the fan continues to run for about three minutes to evaporate the residual condensate in the heat exchanger and then the dehumidifier stops completely.

### Reinsert the water tank.

- Securely place the water tank lid in the slot and insert the water tank fully.
- If the water tank is not properly inserted, the Water Full indicating Lamp remains lit and the dehumidifier does not start.

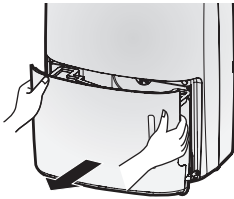

### Empty the water tank.

- Hold the water tank by the handle and carry it to a safe place for draining.
- Open the draining lid and empty the tank. (Hold the draining lid while emptying the tank.)
- When the Start button is pressed again, the compressor does not start running again unless at least three minutes have passed since operation was stopped in order to protect itself.

### CAUTION

- If the water tank is removed immediately after the dehumidifier is stopped, some water may drip from the heat exchanger. (Wipe up the water with a soft cloth.)
- After removing the water tank, do not touch the internal components of the dehumidifier. The water level sensor could malfunction.
- Clean inside the water tank regularly (about once a week).
- The dehumidifier removes less moisture from the air in the winter and at low temperatures.

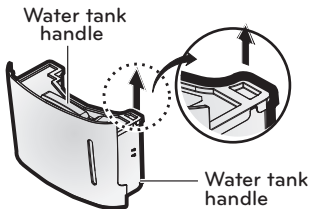

### Moving the product

1. Drain the water



2. Hold the side handles



3. Move the product.  
(Be careful when lifting the product. It may be slippery.)



The dehumidifier can move in any direction.

Always empty the water tank before moving the product to prevent the water overflowing. When moving the product over an uneven surface, lift it. Avoid sliding the product on rollers over vinyl flooring or thick carpet. The flooring or carpet could be damaged.

### Cleaning the dehumidifier

#### Filter

Clean the filter every two weeks

Remove the filter by sliding it left and then remove the Multi Protection Filter(Optional).

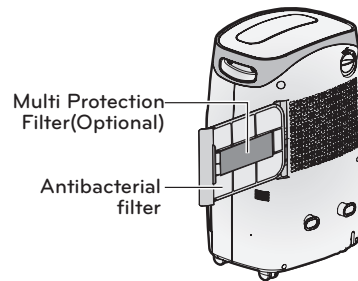
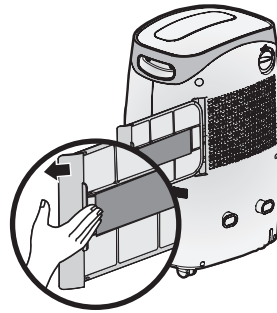

Clean the antibacterial filter with a vacuum cleaner or a soft brush.

- If it is too dirty for that, clean it in water with a neutral detergent. (Do not use hot water of 40°C or above.)



20 USING THE DEHUMIDIFIER

**Clean the Multi Protection Filter with a vacuum cleaner.**

- Make sure that no water gets inside the Multi Protection Filter. (This makes the filter less effective.)
- The Multi Protection Filter should be cleaned monthly and replaced every six months.

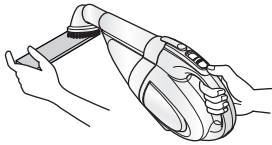

**Completely dry the filter in the shade and fit it along with the Multi Protection Filter. Slide the filter fully to the right until you hear a click.**

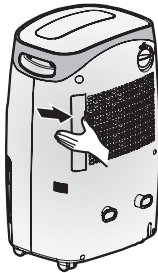

**CAUTION**

- For your safety, pull out the power plug before cleaning.
- After cleaning the antibacterial filter with water, dry it completely in the shade. (Using the filter when it is still damp could result in malfunction.)

**Information**

The filter cleaning service provided by the service center is a paid service.

**Dehumidifier**

**Wipe the product with a soft cloth.**

- Do not clean the dehumidifier with water.
- Cleaning with water could degrade the insulation or stain the exterior.



**CAUTION**

- Do not use the following materials for cleaning.
- They could damage the exterior. Thinner, benzene, acids, abrasive cleaning pads etc.

**Water tank**

**Clean inside the water tank.**

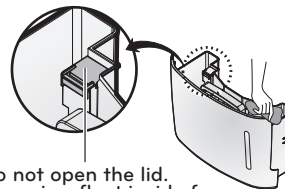

Do not open the lid. There is a float inside for detecting the water level.

### Check regularly

To ensure complete safety, check the following once or twice a year:

#### Is the power plug too hot?

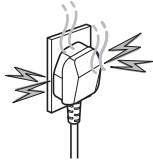

#### Is the cord torn or damaged?



### Storing the dehumidifier

**Pull the power plug out of the wall outlet.**

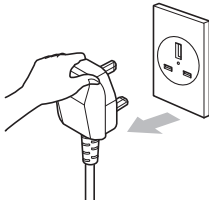

**Completely empty the water tank of any residual water.**

- Remove the water tank lid and clean all moisture off the water tank.

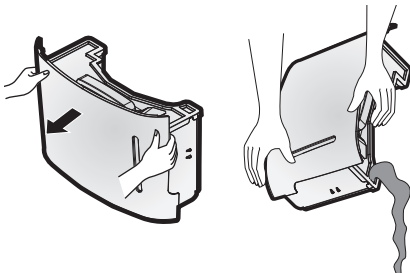

### Clean the filter.

- To prevent deformation, do not dry it in the sun.
- Keep the filter away from fire and direct sunlight when drying it. Dry the filter in the shade.
- Never clean the Multi Protection Filter(Optional) with water.

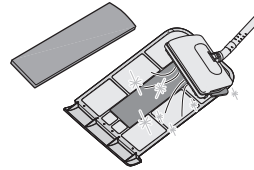

**Let the dehumidifier dry for about half a day in a well-ventilated area away from direct sunlight. Then, place a cover over the dehumidifier to prevent dust settling and store it upright.**

- (The cover for storage is not provided with the product.)

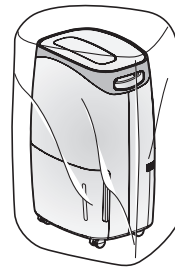

### CAUTION

- Use a soft cloth to clean the product exterior.
- Anything else could scratch or damage the product exterior.
- Using wax or thinner could damage the product exterior.

## TROUBLESHOOTING TIPS

Is there something wrong with the product? Please check the following before contacting the service center.

Problem	Check	What To Do
The product is not running.	<ul style="list-style-type: none"> <li>- Is the power plug correctly inserted into the wall outlet?</li> <li>- Are you experiencing a power outage?</li> <li>- Is the water tank correctly installed?</li> <li>- Is the Tank Full indicator lit?</li> <li>- Is the set humidity set higher than the room humidity?</li> </ul>	<ul style="list-style-type: none"> <li>- Insert the power plug.</li> <li>- Check other appliances.</li> <li>- Install the water tank correctly.</li> <li>- Empty the water tank.</li> <li>- Press the ON button when Auto Defrost ends.</li> <li>- Reduce the set humidity to below the room humidity.</li> </ul>
There is little dehumidification.	<ul style="list-style-type: none"> <li>- Is the dehumidifier running in Air Purifying mode?</li> <li>- Is the room temperature or humidity too low?</li> <li>- Is the air inlet or outlet blocked?</li> </ul>	<ul style="list-style-type: none"> <li>- Select Auto Dehumidifying / Laundry Drying mode.</li> <li>- Check the target humidity.</li> <li>- Use Laundry Drying mode.</li> <li>- It is normal for less dehumidification to take place in the winter and in dry areas.</li> <li>- Remove the obstruction.</li> <li>- Clean the filter.</li> </ul>
Humidity does not seem to decrease much even though the product is running in dehumidification mode.	<ul style="list-style-type: none"> <li>- Is the door/window open?</li> <li>- Is the room too big?</li> <li>- Is there an object generating steam nearby?</li> </ul>	<ul style="list-style-type: none"> <li>- Close the door/window.</li> <li>- Use the dehumidifier in an adequately sized room.</li> <li>- Do not use the dehumidifier together with other appliances.</li> </ul>
The humidity reading on the display is incorrect.	<ul style="list-style-type: none"> <li>- Is the dehumidifier obstructed in any way?</li> <li>- Is the dehumidifier far away from the place you are trying to dehumidify?</li> </ul>	<ul style="list-style-type: none"> <li>- Keep the dehumidifier away from walls etc.</li> <li>- The dehumidifier's display shows the humidity level in its current position, which may be different from the level in other positions.</li> </ul>
It is taking a long time to dry laundry.	<ul style="list-style-type: none"> <li>- Is the dry air reaching the laundry?</li> <li>- Are you trying to dry the laundry in a large room?</li> <li>- Are you trying to dry too much laundry?</li> </ul>	<ul style="list-style-type: none"> <li>- Move the dehumidifier closer to the laundry.</li> <li>- Use the dehumidifier in an adequately sized room.</li> <li>- Reduce the amount of laundry.</li> </ul>
I just removed the water tank and water is dripping from within the dehumidifier.	<ul style="list-style-type: none"> <li>- Did you remove the water tank while the dehumidifier was running?</li> </ul>	<ul style="list-style-type: none"> <li>- Remove the water tank when the Tank Full indicator is lit.</li> </ul>

Call the service immediately in the following situations

1. Power cord is too hot or damaged.
2. Error code is generated by self diagnosis.
3. Water overflow even if the water tank is full.

