



ENGLISH

中文

OWNER'S MANUAL

DEHUMIDIFIER

DUAL Inverter

Please read this manual carefully before operating your set and retain it for future reference.

RD19GQGC1 / RD16GQSC1



P/NO : MFL68026021
Rev04_020218

www.lg.com
Copyright © 2017 - 2018 LG Electronics Inc. All Rights Reserved.





2 SAFETY PRECAUTIONS

SAFETY PRECAUTIONS

The following safety precautions are intended to prevent accidental property damage and personal injury through safe and correct use of the product.

WARNING

Failure to follow the instructions could result in death or serious injury of the user.

CAUTION

Failure to follow the instructions could result in personal injury or property damage.

WARNING

When installing the dehumidifier

- **Do not damage, alter, excessively bend, twist, pull, pinch or heat the power cord.**
If the power cord is damaged, request for repair to the service technician to prevent any risk.
If not, it can cause fire, electric shock or product failure.
- **Do not use multiple-outlet adaptors with this dehumidifier.**
Excessive use of power could result in electric shock or fire.
- **Do not use the product if the outlet is damaged or loose.**
Doing so could result in electric shock or fire.
- **If there is a gas leak, open the window for ventilation before using the dehumidifier.**
Failure to do this could result in explosion, fire or burns.
- **Do not disassemble, repair or modify the product.**
Doing so could result in fire or electric shock.
- **Do not store or use flammable gases or materials near the dehumidifier.**
Doing so could result in fire or product malfunction.
- **This appliance is not intended for use by persons (including children) with reduced physical, sensory or mental capabilities, or lack of experience and knowledge, unless they have been given supervision or instruction concerning use of the appliance by a person responsible for their safety.**
Children should be supervised to ensure that they do not play with the appliance.

When using the dehumidifier

- **Push the power plug all the way into the wall outlet so that it is not loose.**
A loose connection could result in fire.
- **Do not touch the power plug with wet hands.**
Doing so could result in electric shock or injury.
- **Do not modify or extend the power cord.**
Doing so could result in fire or electric shock.
- **If the product makes a strange noise or emits a smell or smoke, pull the power plug out and contact the service center.**
Failure to do this could result in explosion, fire or burns.
- **Avoid placing the dehumidifier or other heavy objects on top of the power cord.**
Doing so could result in fire or electric shock.
- **Do not use water to clean the dehumidifier.**
Doing so could result in electric shock or malfunction.



- **Keep the air inlet and outlet free from obstructions.**
Failure to do this could result in poor performance or malfunction.
- **Do not cover the power cord with a mat etc.**
If heavy objects are placed on the mat, the power cord underneath could be damaged, causing fire or electric shock.
- **Do not place combustion appliances directly in the path of the dehumidifier's airway.**
Doing so could result in incomplete combustion or deformation by heat.
- **Keep the product away from fire.**
Failure to do this could result in fire.
- **Do not use the product in places where it could be splashed by water.**
Doing so could result in fire or electric shock.
- **Do not insert fingers, sticks etc. into the air inlet or outlet.**
You could be injured by the high-speed fan.
- **Only qualified personnel may clean the internal parts. Do not use corrosive detergents.**
Doing so could result in product malfunction, fire or electric shock.

CAUTION

When installing the dehumidifier

- **Do not use the product for purposes other than its intended use.**
This product is not designed for preserving precision instruments, tableware or art works. The quality of the items you are trying to preserve could deteriorate.
- **Ventilate frequently.**
Keep the area well ventilated, especially if you are using a combustion appliance as well. Inadequate ventilation reduces the oxygen level in the air.
- **Always hold the plug head when pulling the power plug.**
Failure to do so could result in electric shock or injury.
- **Do not use excessive force when pulling the extension hose.**
Doing so could result in damage to or deformation of the hose.
- **Do not use the product in places where chemicals are used.**
Chemicals and solvents dissolved in the air in places such as hospitals, factories, laboratories and hair salons could cause the product to become deformed, causing the dehumidified water to leak and wet nearby household items, equipment etc.
- **Turn off the dehumidifier and pull out the power plug before cleaning.**
If you do not do this, you could be injured by the high-speed fan.
- **DO NOT operate the dehumidifier without a filter.**
Using the product without a filter could result in a reduced product lifespan, electric shock or injury.

When using the dehumidifier

- **Do not use the product for preserving animals/plants, precision instruments, art works etc.**
It may cause property damage.
- **Do not place vases or water jars on the dehumidifier.**
If the water flows into the dehumidifier, it could result in fire or electric shock.
- **Product must be placed on safe and hard surface floor.**
On weak surface floor, product is prone to vibration and noise.
Product must stand upright, otherwise it causes defect and water leakage.



4 SAFETY PRECAUTIONS

- **Turn off the dehumidifier and empty the water tank before moving the dehumidifier.**
The water could overflow from the tank, wetting household items or causing fire or electric shock.
- **Pull out the power plug if you will not be using the product for an extended period.**
Failure to do this could result in product malfunction or fire.
- **Do not use the product in a very small space such as a closet.**
Poor ventilation could result in overheating or fire.
- **Do not use wax, thinner or a strong detergent when cleaning. Wipe the product using a soft cloth.**
Using inappropriate cleaning products could cause the product to become discolored or develop surface flaws.
- **Do not use the product in direct sunlight or rain.**
The product could overheat, causing fire or electric shock.
- **Do not touch the product with wet hands.**
Doing so could result in electric shock. Position the product on a firm, stable surface.
- **If the product is on an unstable surface, it may vibrate and make noise.**
If the product is tilted or laid down, the dehumidified water could overflow and the product could malfunction.
- **Do not keep the power cord tied up when using the product.**
The power cord could overheat, resulting in fire.
- **Do not spray foreign substances or water into the sensor hole.**
This could result in electric shock or malfunction.
- **Do not use the product at unstable voltage for a long period of time.**
The product may stop automatically to protect itself. This could result in electric shock or malfunction.
- **Do not allow child to mount on the product.**
It may cause serious injury and also product defect.





TABLE OF CONTENTS

2 SAFETY PRECAUTIONS

6 QUICK START

7 NAME OF EACH PART

- 7 Front side
- 7 Back side
- 8 Display Panel

9 CHECKLIST BEFORE USAGE

10 HOW TO USE

- 11 Smart Dehumidification
- 12 Jet Dehumidification
- 12 Silent Dehumidification
- 13 Spot Drying
- 14 Laundry Drying
- 15 Ionizer
- 15 Defrost Operation
- 15 Auto Clean
- 16 Bucket full
- 17 OFF Timer
- 17 Timer function
- 18 Lock Function
- 19 How to empty water tank
- 20 Product registration through Wi-Fi function

21 SMART FUNCTIONS

- 21 Using Smart ThinQ Application

23 HOW TO CLEAN

- 23 How to clean the exterior and inlet of the dehumidifier
- 23 How to clean water tank
- 24 How to clean Pre-Filter

25 HOW TO STORE

26 TROUBLESHOOTING TIPS

27 PRODUCT SPECIFICATIONS





6 QUICK START

QUICK START

Dehumidifier efficiency varies depending on room temperature and relative humidity.

- A lower temperature and lower relative humidity will reduce the moisture removal rate.
- The compressor operates in dehumidification mode only when the set humidity is lower than the room humidity.

The operating temperature is 5°C to 32°C.

- The dehumidifier cannot be used at 0°C or below because the dehumidified water could freeze.
- At 32°C or higher, the dehumidifier may stop running automatically to protect itself from overheating.

The room temperature increases while the dehumidifier is running.

- This dehumidifier does not have temperature control functions.
- The dehumidifier generates heat while operating, raising the room temperature by about 2°C or 3°C depending on the usage conditions (room air pressure and room size).

The dehumidification can be restarted after three minutes.

- If you attempt to restart the dehumidifier immediately after stopping it, the compressor will start running again after about three minutes for product safety reasons.



NAME OF EACH PART

Front side

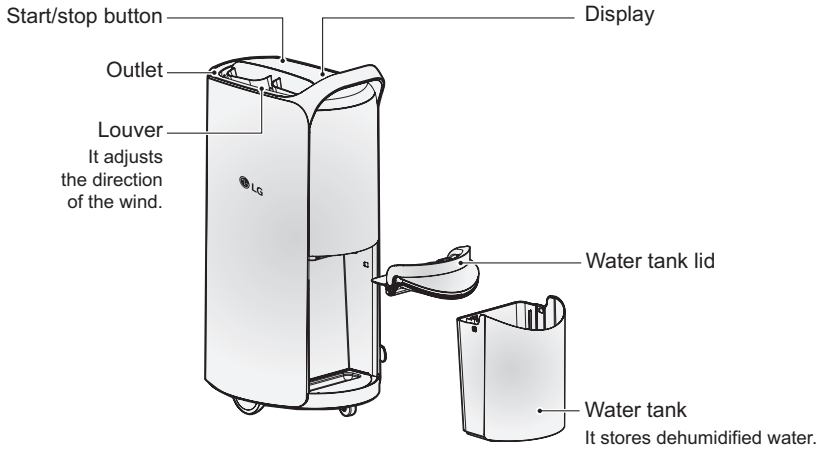

Back side

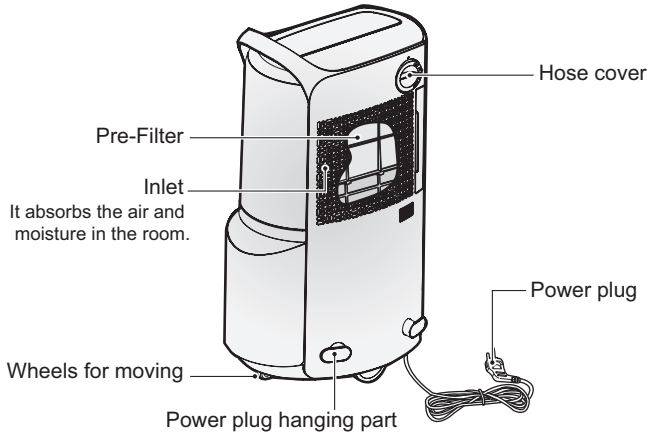

* The components are at the top part of the product packaging box.

* The form of water container may differ in each product.



Extension hose



Shoes drying hose



Laundry drying hose





8 NAME OF EACH PART

Display Panel

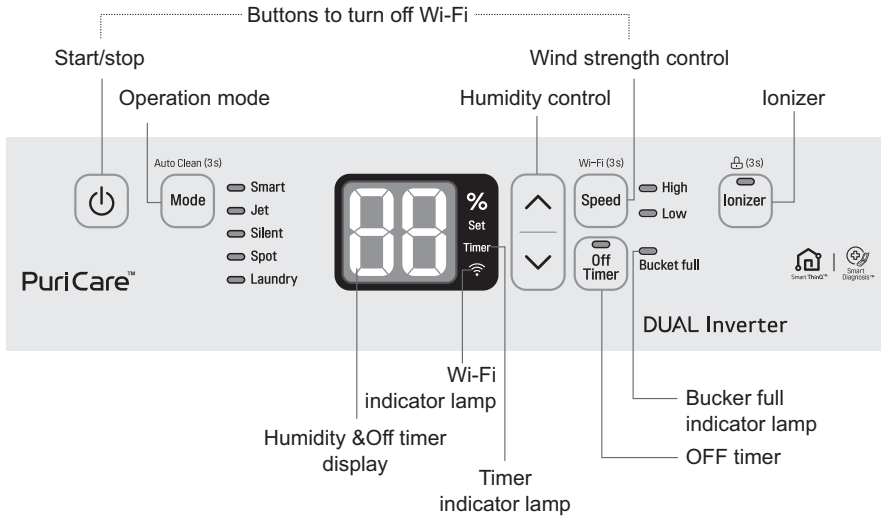

Start/stop button	It is used to start and stop the product operation.
Operation mode button	It is used to switch to Smart dehumidification mode, Jet dehumidification mode, Silent dehumidification mode, Spot drying mode, and Laundry drying mode. Smart dehumidification → Jet dehumidification → Silent dehumidification → Spot drying → Laundry drying → Smart dehumidification The automatic dry function will turn on/off after depressing the button for 3 seconds or more.
Ionizer button	It is used to remove harmful bacteria in the air. When you press the button for 3 seconds, lock function is operated.
Humidity control button	It controls the desired humidity. (30%~70%) Humidity control can be set in the units of 5%.
Wind strength control button	It controls the wind strength. When you press the button for 3 seconds, Wi-Fi pairing is operated.
Buttons to turn off Wi-Fi	Pressing and holding the Start/Stop button and the Wind strength control button at the same time for more than 3 seconds turns off Wi-Fi. * After finishing product registration and while Wi-Fi is off, pressing and holding the button for more than 3 seconds turns on Wi-Fi and you can control the product from your smart-phone that has been previously registered.
OFF timer button	The product will be turned off after the set time. When the button is pressed, it is increased by 1 hour each time, and you can set up to 8 hours.
Operation mode lamp	It displays the currently set operation mode.
Humidity & Off timer display	It displays the current humidity and set humidity. When Off timer is set, it displays the Off timer time, and it automatically displays the current humidity after completing the setting.
Wi-Fi indicator lamp	It is displayed when Wi-Fi function is set.
Timer indicator lamp	It is displayed when timer is set in Wi-Fi app.
Set indicator lamp	It is displayed when humidity is set. Desired humidity is displayed with "set" light, and the light is turned off when showing current humidity.

ENGLISH





CHECKLIST BEFORE USAGE

Dehumidification amount changes according to indoor temperature and relative humidity.

- If the temperature or relative humidity is low, dehumidification amount is decreased.
- Dehumidification is performed with compressor operation only when the desired humidity is lower than the current humidity.

The product can operate in the temperature boundary of 5°C~32°C.

- At 0°C or less, dehumidified water will freeze, and dehumidification cannot be performed.
- If it is over 32°C, the temperature inside the dehumidifier will rise, and there will be cases of stopping the operation by protective device activation to avoid excessive usage.

When the dehumidifier is under operation, the indoor temperature will rise.

- Dehumidifier does not have a cooling/heating function.
- Heat is generated during the operation, so the temperature may be increased by about 2°C~3°C according to the usage conditions (indoor temperature, size of the room).

Operation will restart after 3 minutes.

- If it is restarted right after the stop, the compressor will start about 3 minutes after to protect the product.

It automatically protects the product during the continuous operation.

If it is operated for 24 hours or more continuously, the compressor will stop automatically to protect the product, and it will restart after 1 hour.

Please have gap of 30cm or more from the wall.

If it is not ventilated well, the air suction performance will be degraded.

There may be water remaining in the drain water tank at the first time usage.

There may be water remaining in the drain water tank by the product outgoing inspection to check the normal operation of the product. It is not a failure.



HOW TO USE

Push start/stop button.

- The louver opens and smart dehumidification starts.
But, if no other button is pressed (Mode, Speed etc.), the desired humidity will change to 50% after 30 minutes of continuous operation.
- The current humidity is displayed on The humidity & Off timer display.

Press operation mode button to select desired operation mode among smart dehumidification, jet dehumidification, silent dehumidification, spot drying, and laundry drying mode.

- The selected operation indicator lamp is lighted.
- The selected operation mode starts after 3 seconds.

Press Humidity Control \wedge / \vee button to change humidity.

- Desired humidity can be set to 30 \leftrightarrow 35 \leftrightarrow 40 \leftrightarrow 45 \leftrightarrow 50 \leftrightarrow 55 \leftrightarrow 60 \leftrightarrow 65 \leftrightarrow 70.
Humidity can be set with the units of 5%.
- During the humidity setting, desired humidity is displayed on the humidity display part, and the current humidity is displayed after about 5 seconds.
- Current humidity is displayed in the units of 5% from 25~90%.
If it is less than 25%, it is displayed as 25%, and if it is 90% or more, it is displayed as 90%.

Press Wind Strength Control button to change wind amount.

You can set the wind amount to low or high wind.

To stop the product, press start/stop button one more time.

- Louver closes.
- All lamps will be turned off and the product stops.

CAUTION

- If the product started again right after stopping the operation, dehumidification operation does not start for about 3 minutes to protect the compressor.

Smart Dehumidification

To maintain pleasant indoor condition

- If you press Operation Mode button to select Smart dehumidification mode and set the desired humidity, it maintains the humidity set by the user.
- Once the humidity level reaches the desired humidity, the compressor stops and only the fan operates. If relative humidity goes up, it will operate dehumidification again.
- The wind strength is set to high wind as default, and you can set wind strength and desired humidity.
- When the current humidity reaches the desired humidity, the compressor stops, and operates in wind only mode.

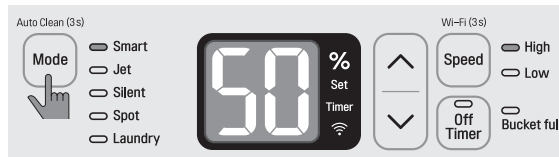



12 HOW TO USE

Jet Dehumidification

When you want to remove indoor moisture quickly

- Press Operation Mode button to select Jet dehumidification mode.
- Under Jet dehumidification mode, it will change to Smart dehumidification mode after 60 minutes. Even if it is under power wind (Po) operation, high wind indicator lamp is lighted.
- When it is in Jet dehumidification mode, if you select Humidity control button or Speed button, it switches to Smart dehumidification.
- If it changes from Smart/Silent dehumidification to Jet dehumidification, the desired humidity selected in another operation mode is set.

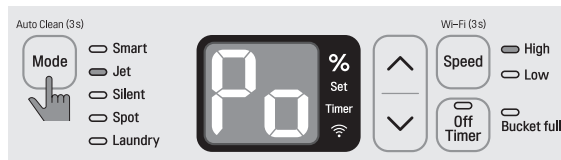

Silent Dehumidification

When you want dehumidification in silent mode

- Press Operation Mode button to select Silent dehumidification mode.
- Silent dehumidification operation makes silent and pleasant room even during the night.
- The wind strength is set to low wind as default, and you can set wind strength and desired humidity.



Spot Drying

When you need spot drying of shoes, closet, etc.

- Press Operation Mode button to select Spot drying mode.
- In Spot drying mode, the louver is closed.
- Wind amount is set to high wind, and humidity control & the wind amount is not operational.
- The current humidity is displayed in the humidity display window.
- Use the product by connecting shoes drying / closet drying kit through the extension hose as necessary.

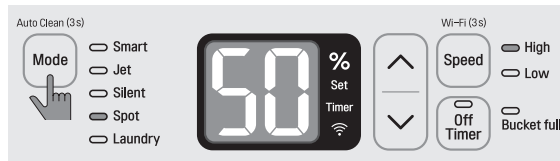

How to use Spot drying mode

Open the hose cover at the back of the product by turning it counterclockwise.

After inserting Spot drying extension hose, fix it by turning it clockwise.

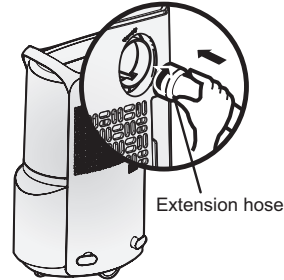
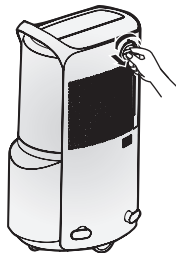

Extend the hose to make it face the desired drying direction.

Connect shoes drying kit or closet drying kit to the extension hose.

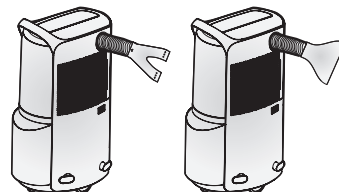
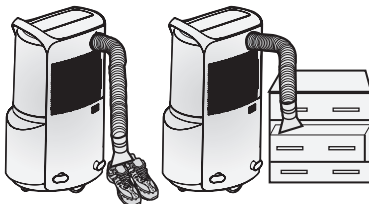

* The form of water container may differ in each product.



14 HOW TO USE

CAUTION

- Do not move the dehumidifier by holding the extension hose. Dehumidifier may fall down and cause injury.
- If spot drying operation is used for long period of time, the operation may stop to protect the product.

Laundry Drying

When you want to dry laundry continuously regardless of the ambient humidity

- Press Operation Mode button to select Laundry drying mode.
- The wind strength is set to high at default, and you can change the wind strength. You cannot set desired humidity.
- Louver operates up and down.



CAUTION

When drying laundry, be careful not to have laundry water drop on to the dehumidifier.

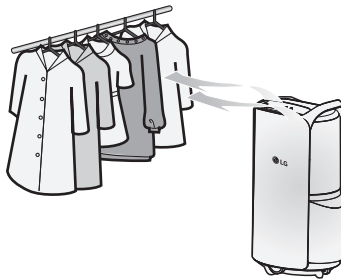

* The form of water container may differ in each product.



Ionizer

When you want to remove harmful bacteria in the air

- Select it by pressing Ionizer button.
- It removes harmful material in the air such as bacteria, virus, etc. using ionized air.
- You can use Ionizer function and dehumidification function at the same time.
- Ionizer can be used at any time regardless of dehumidifier function.

Defrost Operation

If there is frost in the heat exchanger due to low indoor temperature, it automatically removes the frost.

- During the operation, if 'dF' is displayed on the display, it automatically runs the defrost in the heat exchanger inside the product.
- Compressor is stopped during the automatic defrost operation.

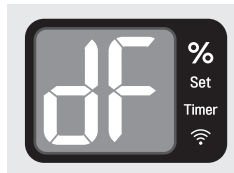

Auto Clean

This function dries inside of the dehumidifier in order to prevent mold or germs.

- Press the operation mode button for about 3 seconds during operation to set up Auto Clean.
- Each time the operation mode button is pressed for 3 seconds: Auto Clean → settings cancellation - then it repeats
- When running Auto Clean a [] is displayed on the display.
- After Auto Clean function finishes, the LED display automatically turns off.
- When the operation stops, the Auto Clean will start.

When Auto Clean function starts, the dehumidifier will run the fan for a certain period in order to remove moisture inside the product. (Duration: about 5 minutes)



16 HOW TO USE

Bucket full

**When the water tank is full, operation automatically stops, bucket full lamp is lighted, and warning buzzer sounds.
(Warning buzzer will sound one more time after 1 minute.)**

- When the full water is detected, the dehumidification function immediately stops, and fan operates for 5 minutes to remove the remaining condensed water.
- Bucket full lamp is lighted on the display panel, and the product operation stops.
- After draining, when you insert water tank again, bucket full lamp is turned off, and operation starts again automatically.

! CAUTION

Cautions when you drain the water

Carefully take out the drain water tank.

If you pull the water tank too hard, the water inside may spill over.

When you take out the water tank, make sure to stop the product.

If you take out the water tank during the operation, compressor will stop, and fan will operate for 5 minutes to vaporize the remaining condensed water in the heat exchanger before stopping the operation.

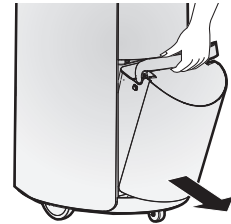

* The form of water container may differ in each product.

! CAUTION

- Lamp will turn on if water tank is not correctly placed. Check if water tank fully and correctly placed.
- When you move the product or shock is imposed to the product, Bucket full lamp may be lighted.
- Drain the water inside the water tank, and reassemble the water tank.

OFF Timer

Check if it is under operation and press OFF timer button.

- OFF timer switches in the following order, so select the setting time.

(1 hour gap) → 1 → 2 → ... → 8 → No display

- The remaining time is displayed as time goes.
- When it passes the selected time, operation stops.

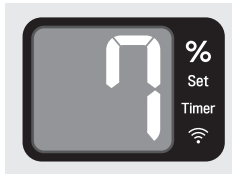

To cancel OFF timer

- If you press OFF timer button repeatedly until the time display disappears in the OFF timer display part, it will be cancelled.

CAUTION

Drain the water inside the water tank and then set the time.

If water tank becomes full during OFF timer operation, bucket full indicator lamp is lighted and the dehumidification stops.

Timer function

Various kinds of reservation including the power on/off can be made by the **Smart ThinQ application**. (Execute Smart ThinQ Application → Select the dehumidifier product → Make reservation)

* For more detailed description on the use of Smart ThinQ, refer to the Using the Smart Functions section.

* You can set the timer time through app.

• **You can set the timer function only through Smart ThinQ app.**

(Run Smart ThinQ app → Select dehumidifier product → set timer time)

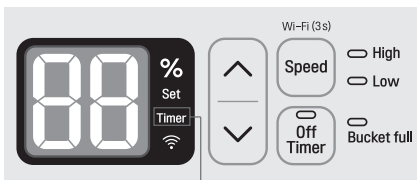

When timer function is set through app, the timer set display part is lighted.



18 HOW TO USE

Lock Function

Press the lonizer button for 3 seconds.

- If you take off your hand when the buzzer sounds 1 time after 3 seconds, it enters Lock function.
- "CL" display in the display panel is maintained for 5 seconds.
- It maintains the operation state at the time of setting the function until the function is turned off, and there will be no response even if a button is pressed.
- If you press other buttons in Lock function set state, warning sound is generated 3 times, and 'CL' display is displayed in the display panel for 5 seconds.
- You can set the function regardless of whether the product is in operation.

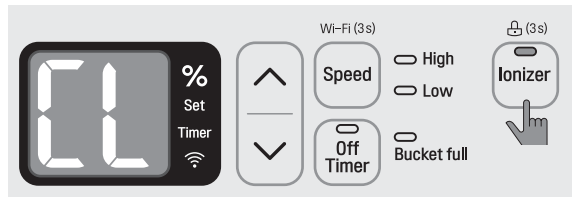

To unlock

- Press the lonizer button for 3 seconds.
- After 1 buzzer sound after 3 seconds, if you take off your hand, the lock function will be turned off.



How to empty water tank

Hold the top handle of the water tank and softly take it out.

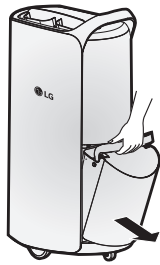

Open the drain lid of the water tank.

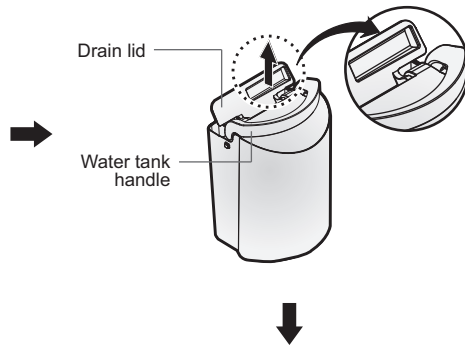

First insert the bottom part of the water tank correctly into the hole, and then push it in.

Pour out the water inside the water tank.

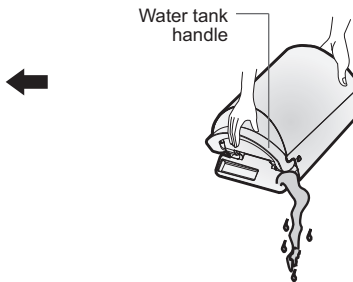
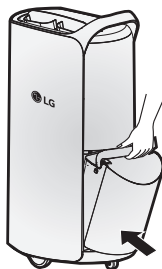

※ The form of water container may differ in each product.

⚠ CAUTION

- If the water tank is taken out right after stopping the operation, there are cases of water remaining in the heat exchanger dropping into the main unit. (Wipe the dropped water with soft cloth.)
- After taking out the water tank, do not touch inside the main unit. It will cause failure of the full water detection device.
- Periodically clean inside the water tank (about 1 time per week).
- If it is used during winter or at low temperature, there is less moisture in the air, so dehumidification amount is also decreased.
- When you take out the water tank, make sure to stop the product. If you take out during operation, the compressor will stop and the fan operates for 5 minutes to vaporize the remaining condensed water inside the heat exchanger before complete stop.



Product registration through Wi-Fi function

1. Press  button to start dehumidifier operation.
2. Check the information (Wi-Fi network name, password) of AP at the place where the dehumidifier is installed.
3. Proceed with the product registration after log-in through the smart phone's Smart ThinQ app.
 - For Wi-Fi function registration, according to app guide, press speed button for 3 or more seconds. (For details, refer to Smart ThinQ App connection guide)

* Check if the product display's Wi-Fi indicator lamp is blinking. To send the network information, Wi-Fi indicator lamp blinking is maintained for about 5~10 minutes.

CAUTION

- If the distance between dehumidifier and wireless AP is long, the equipment will not work smoothly.
- If wireless AP does not work, Smart ThinQ app related functions cannot be used.

SMART FUNCTIONS

Using Smart ThinQ Application

Installing Smart ThinQ

Search for the LG Smart ThinQ application from the Google Play Store or Apple App Store on a smart phone. Follow instructions to download and install the application.

Product Registration

- 1 Run the LG Smart ThinQ application on a smart phone.
- 2 Create an account and sign in.
- 3 Select Register.
- 4 Select Dehumidifier.
- 5 Follow the instruction on the smart phone.

Wi-Fi Function

- For appliances with the  logo

Communicate with the appliance from a smart phone using the convenient smart features.

Using the Application

- 1 Select the appliance in the application and connect it to a Wi-Fi network.
- 2 Select the menu on the upper right side to access settings and features.

Firmware Update

Keep the appliance performance updated.

Smart Diagnosis™

If you use the Smart Diagnosis function, you will be provided with the useful information such as a correct way of using the appliance based on the pattern of use.

Settings

Allows you to set various options on the appliance and in the application.

NOTE

- To verify the Wi-Fi connection, check that Wi-Fi  icon on the control panel is lit.
- LG Smart ThinQ is not responsible for any network connection problems or any faults, malfunctions, or errors caused by network connection.
- The machine supports 2.4 GHz Wi-Fi networks only.
- If the appliance is having trouble connecting to the Wi-Fi network, it may be too far from the router. Purchase a Wi-Fi repeater (range extender) to improve the Wi-Fi signal strength.
- The Wi-Fi connection may not connect or may be interrupted because of the home network environment.
- The network connection may not work properly depending on the internet service provider.
- The surrounding wireless environment can make the wireless network service run slowly.
- The application is subject to change for appliance improvement purposes without notice to users.
- Functions may vary by model.



22 SMART FUNCTIONS

Wireless LAN Module Specifications

Model	LCW-003
Frequency Range	2412 to 2472 MHz
Output Power(Max)	IEEE 802.11b:18.37 dBm IEEE 802.11g:17.67 dBm IEEE 802.11n:17.67 dBm



Open Source Software Notice Information

To obtain the source code under GPL, LGPL, MPL, and other open source licenses, that is contained in this product, please visit <http://opensource.lge.com>.

In addition to the source code, all referred license terms, warranty disclaimers and copyright notices are available for download.

LG Electronics will also provide open source code to you on CD-ROM for a charge covering the cost of performing such distribution (such as the cost of media, shipping, and handling) upon email request to opensource@lge.com. This offer is valid for three (3) years from the date on which you purchased the product.

Smart Diagnosis™ Using a Smart Phone

- For appliances with the  or  logo

Use this function if you need an accurate diagnosis by an LG Electronics customer information centre when the appliance malfunctions or fails.

Smart Diagnosis™ can not be activated unless the appliance is connected to power. If the appliance is unable to turn on, then troubleshooting must be done without using Smart Diagnosis™.

- 1 Open the **LG Smart ThinQ** application on the smart phone.
- 2 Select the Dehumidifier in dashboard.
- 3 Press Start Smart Diagnosis button.
- 4 Follow the instructions on the smart phone.

NOTE

- The Smart Diagnosis™ function depends on the local call quality.
- If the Smart Diagnosis™ data transfer is poor due to poor call quality, you may not receive the best Smart Diagnosis™ service.
- Be sure to keep ambient noise to a minimum or the phone may not correctly receive the buzzer beeps from the indoor unit.



HOW TO CLEAN

How to clean the exterior and inlet of the dehumidifier

Soak soft cloth in water, squeeze out water, and wipe the dehumidifier.

- Do not spray water directly on the main unit.
- If you wash the main unit with water, insulation may be degraded or stain may be formed.

Remove dust using vacuum cleaner or soft brush.

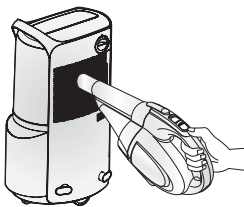

! CAUTION

Do not use the following material.
It may damage the exterior. (thinner, benzene, acid, sponge, etc.)

How to clean water tank

Press the fixing part on both sides of the water tank to take out the lid.

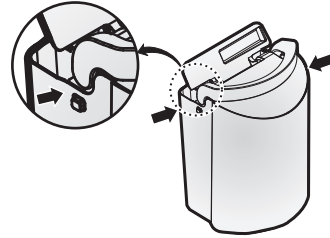

Wipe the water inside the water tank.

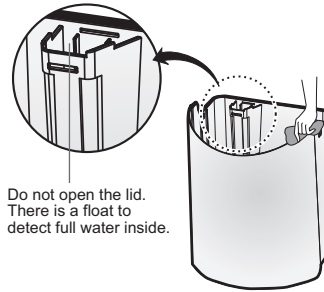

! CAUTION

If the float is fallen off or assembled incorrectly, there may be water leakage.

* The form of water container may differ in each product.



24 HOW TO CLEAN

ENGLISH

How to clean Pre-Filter

Push Pre-Filter to the right to take it out.

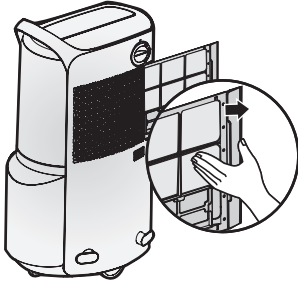

Clean the Pre-Filter with vacuum cleaner or soft brush.

- If the contamination is severe, wash with water using neutral detergent. (Do not use hot water of 40°C or higher.)
- The cleaning period for Pre-Filter is 1 month.



Completely dry in shade and push to the left until the Pre-Filter is not pushed any more.

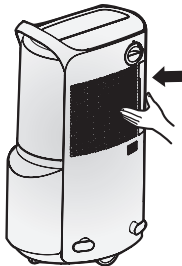

* The form of water container may differ in each product.

! CAUTION

- For the safety, pull out the power plug before cleaning.
- After washing the Pre-Filter with water, completely dry it in shadow. (If there is moisture, it may cause failure.)



HOW TO STORE

Pull out the power plug from the socket.

Completely drain the water remaining inside the water tank.

- Separate the water tank lid and wipe the water inside the water tank.

Clean the filter.

- If it is dried under sunlight, it may be deformed.
- During the drying, avoid fire or direct sunlight, but dry in shadow.

After drying at a place without direct sunlight and with good ventilation for about half a day, make sure to store with covering it up and have it stand straight up to prevent dust entering.

(A separate cover for product storage is not provided.)

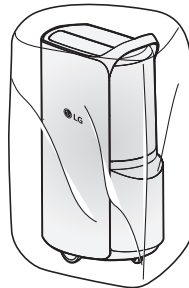

* The form of water container may differ in each product.



TROUBLESHOOTING TIPS

Is there something wrong with the product? Please check the following before contacting the service center.

Problem	Check	What To Do
The product is not running.	<ul style="list-style-type: none"> - Is the power plug correctly inserted into the wall outlet? - Are you experiencing a power outage? - Is the water tank correctly installed? - Is the Tank Full indicator lit? - Is the display showing dF? <ul style="list-style-type: none"> - Is the set humidity set higher than the room humidity? 	<ul style="list-style-type: none"> - Insert the power plug. - Check other appliances. - Install the water tank correctly. - Empty the water tank. - Press the Start button when Auto De-frost ends. - Reduce the set humidity to below the room humidity.
There is little dehumidification.	<ul style="list-style-type: none"> - Is the dehumidifier running in Ionizer? - Is the room temperature or humidity too low? - Is the air inlet or outlet blocked? 	<ul style="list-style-type: none"> - Select Auto Dehumidifying / Laundry Drying mode. - Check the target humidity. - Use Laundry Drying mode. - It is normal for less dehumidification to take place in the winter and in dry areas. - Remove the obstruction. - Clean the filter.
Humidity does not seem to decrease much even though the product is running in dehumidification mode.	<ul style="list-style-type: none"> - Is the door/window open? - Is the room too big? - Is there an object generating steam nearby? 	<ul style="list-style-type: none"> - Close the door/window. - Use the dehumidifier in an adequately sized room. - Do not use the dehumidifier together with other appliances.
The humidity reading on the display is incorrect.	<ul style="list-style-type: none"> - Is the dehumidifier obstructed in any way? - Is the dehumidifier far away from the place you are trying to dehumidify? 	<ul style="list-style-type: none"> - Keep the dehumidifier away from walls etc. - The dehumidifier's display shows the humidity level in its current position, which may be different from the level in other positions.
It is taking a long time to dry laundry.	<ul style="list-style-type: none"> - Is the dry air reaching the laundry? - Are you trying to dry the laundry in a large room? - Are you trying to dry too much laundry? 	<ul style="list-style-type: none"> - Move the dehumidifier closer to the laundry. - Use the dehumidifier in an adequately sized room. - Reduce the amount of laundry.
I just removed the water tank and water is dripping from within the dehumidifier.	<ul style="list-style-type: none"> - Did you remove the water tank while the dehumidifier was running? 	<ul style="list-style-type: none"> - Remove the water tank when the Tank Full indicator is lit.

Call the service immediately in the following situations

1. Power cord is too hot or damaged.
2. Error code is generated by self diagnosis.
3. Water overflow even if the water tank is full.



PRODUCT SPECIFICATIONS

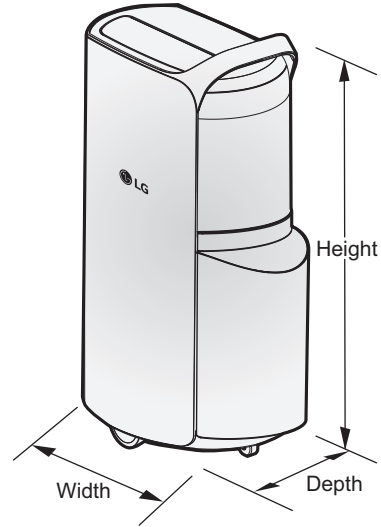
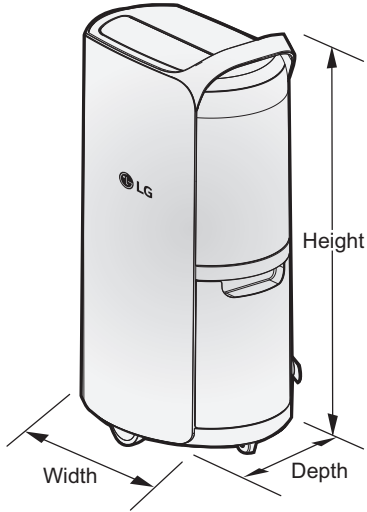

The exterior and design as well as the product specifications may change to enhance the quality of the product.

Model	RD16GQSC1	RD19GQGC1
Power	AC 220~240V, 50 Hz	AC 220~240V, 50 Hz
External Dimensions (Height x Width x Depth)	685 mm X 382 mm X 296 mm	685 mm X 415 mm X 296 mm

