



Model Number:
HCT-D70EIP-A (TDA70EIP)
Portable Dehumidifier with Internal Pump
Operating Instructions



V.140528

General Dehumidifier Information

RECOMMENDED HUMIDITY LEVELS

- Spring/Summer: 30% - 50%
- Fall/Winter: 30% - 40%

WARM AIR EXHAUST IS NORMAL

During operation your dehumidifier will exhaust warm air from the side of the unit. This is normal operation.

EMPTYING THE BUCKET

The more moisture your dehumidifier removes from the air, the more often you may have to empty the bucket (unless you are using the continuous drainage option). The number of times the bucket will be emptied depends on the dehumidifier model.

Model Number Reference Number	Pints of moisture removed per every 24 hour period	Maximum number of times to empty the bucket when operating at full capacity during a 24 hour period
HCT-D70EIP-A TDA70EIP	70 Pints	5 Times

LESS MOISTURE BEING REMOVED OVER TIME IS A GOOD THING!













Using a dehumidifier will cause your area to maintain a more comfortable humidity level. Over time, this humidity level will become more and more stable. Due to the stable humidity level in the area, the dehumidifier will need to remove less and less moisture over time.

Please do not be concerned if the dehumidifier is removing less moisture from the air or the bucket is taking longer to fill up. This is a direct result of your dehumidifier creating a more stable humidity level in your area.

WATER IN THE BUCKET!

There might be a small amount of water present in the bucket before using the dehumidifier for the first time, which is normal. This is caused by the preliminary testing done by the factory.

FEATURES

	Removes up to 70 pints of moisture from the air every 24 hours. This is not the bucket size.
	Adjustable humidistat for precise humidity control.
	Digital humidistat displays set humidity level and current room humidity level.
	Operates at temperatures down to 41°F. Perfect for basement use in the winter.
	Automatic defrost function melts away ice from frozen coils for continuous, worry-free operation.
	3-Speed fan allows you to choose between maximum dehumidifying power or quiet operation.
	Bucket full indicator and audible alarm signals as soon as the bucket is full and ready to be emptied.
	Ultra quiet operation allows for use almost anywhere. Perfect for heavy traffic areas like a family room or bedroom.
	Loss of power protection remembers all settings even when power is interrupted.
	Auto-restart automatically continues operation when power is restored. No need to manually restart the dehumidifier.
	24-Hour Timer automatically turns on and off the unit after the preset time of 0.5 up to 24 hours.
	MyHome modes allow you to choose the location in which you are using your dehumidifier (Sleeping Space, Living Space or Basement) for preset comfort and balanced operation.
	Internal Pump lets you run the unit in continuous mode and never empty the bucket. Use near a drain, sink or window for continuous operation.

Thank you for choosing a Soleus Air Fueled by TCL Portable Dehumidifier. This owner's manual will provide you with valuable information necessary for the proper care and maintenance of your new product. Please take a few moments to thoroughly read the instructions and familiarize yourself with all the operational aspects of your new Dehumidifier.

For your own records, please attach a copy of your sales receipt to this manual. Also, write the store name/location, date purchased, and serial number below:

Store Name: _____

Location: _____

Date Purchased: _____

Serial Number (located on back of unit): _____

IMPORTANT INSTRUCTIONS

Before installing and using your dehumidifier, please read this owner's manual carefully. Store this manual in a safe place for future reference.

- 1) Always place the unit on a level surface.
- 2) Never use or store gasoline or other flammable vapor or liquid near this unit unless instructed by this manual.
- 3) Maintain at least 12-18 inches clearance space around this unit. Do not block or cover air inlet or outlet grilles.
- 4) The unit must be connected to a correctly grounded power supply.
- 5) Do not start or stop the unit by inserting or pulling out the power plug.
- 6) Do not use an adapter plug or extension cord.
- 7) Do not use the unit in the immediate surroundings of a bath, a shower or a swimming pool.
- 8) Do not insert anything into the air outlet. Do not obstruct air inlet or outlet grills unless instructed by this manual.
- 9) Do not let children play near this unit.
- 10) Always inspect the cord for signs of damage before use. If the power cord is damaged, it must be replaced by the manufacturer or a qualified service technician.
- 11) When cleaning the unit, always turn the unit off and unplug the power cord.

PACKAGE CONTENTS

- (1) Portable Dehumidifier
- (1) Operating Instructions
- (4) Casters
- (1) Pump Drain Hose Kit (Hose, Adapter and Gasket)

SPECIFICATIONS

- Noise level is measured at a distance of 3.28 ft away from the front of the unit.
- Power consumption is measured when the fan runs at the highest speed setting.
- These specifications are for reference only. For actual data, please refer to the rating label on the back of the unit.

Model Number Reference Number	HCT-D70EIP-A TDA70EIP
Dehumidifying Capacity	70 Pints per day
Power Consumption (Watts)	730 Watts
Air Flow Volume (High/Med/Low)	320 / 290 / 250 CFM
Power Source	115 V / 60 Hz
Rated Current (Amps)	6.5 A
Sound Pressure Level (High/Med/Low)	53/51/49 dB(A)
Weight	49.4 lbs
Dimensions (W x D x H)	15.25" W x 11.25" D x 24.875" H
Energy Star	Yes
Bucket Capacity	14.8 Pints

DISCLAIMER

ALL INFORMATION AND THE TECHNICAL SPECIFICATIONS PRESENTED IN THIS USER'S MANUAL ARE THE PRESENTATION OF THE MANUFACTURER. SOLEUS HOME COMFORT HAS NOT CONDUCTED INDEPENDENT TEST TO THE INFORMATION AND THE SPECIFICATIONS PRESENTED HEREWITHIN.

CASTER INSTALLATION

- 1) Remove casters from the bucket.

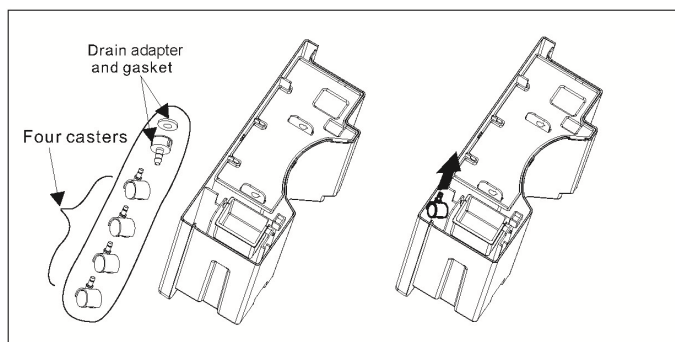

- 2) Tilt the dehumidifier no more than 45° and forcibly insert the casters. Make sure the ring around the caster is flush against the bottom of the dehumidifier.

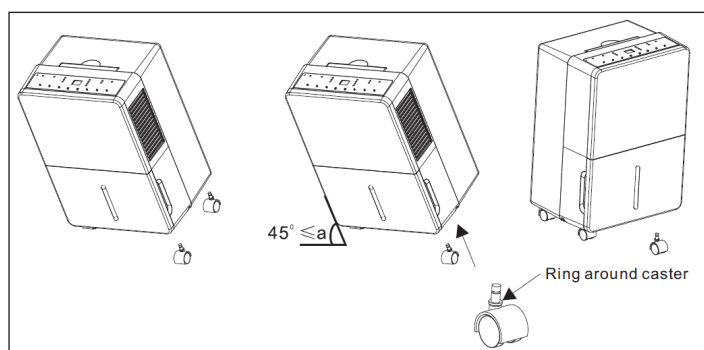

CONTROL PANEL & DIGITAL DISPLAY

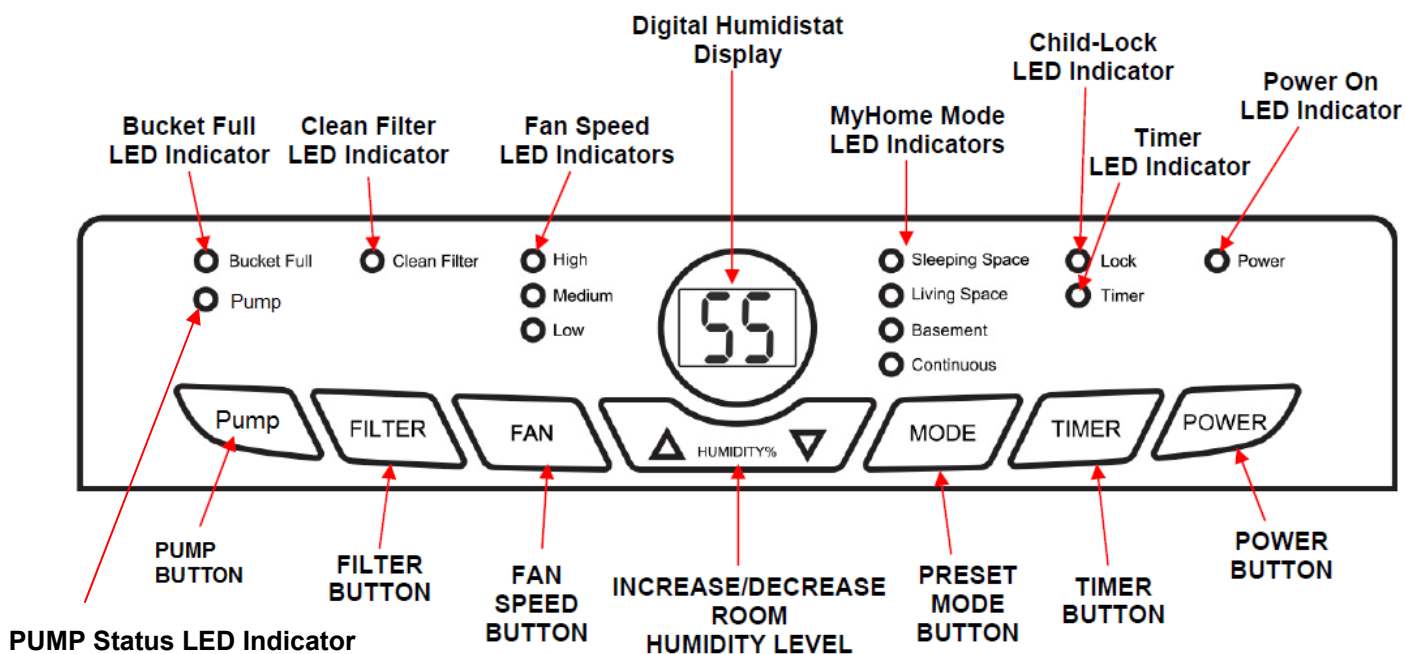

OPERATING INSTRUCTIONS

OPERATING INSTRUCTIONS

- 1) **When first operating the dehumidifier, run it in Continuous mode for 24 hours.**
- 2) **Power On and Off** - Press the **POWER** button once to manually turn the unit on. Press the **POWER** button once more to turn the unit off.
- 3) **Humidity Selection** - Press the Δ or ∇ buttons to choose the desired relative humidity in the room. Each press of the button will change the desired room humidity by 5%. The room humidity is selectable from 35%-80% or continuous. The unit will cycle on and off to maintain the humidity level chosen on the digital display. If you want the dehumidifier to operate continuously regardless of the room humidity, press the **MODE** button until you see “**CO**” on the digital display. This will enable **continuous operation** and the “**Continuous**” indicator will light up on the control panel.
- 4) **Fan Speed Control** - Press the **FAN SPEED** Button to cycle through the different fan speeds: **High, Medium, and Low**. The fan speed can be visually distinguished by the fan speed indicators on the control panel.
- 5) **Timer Auto On**- To program the unit to automatically turn on, press the **TIMER** button when the unit is off. Press Δ or ∇ to increase or decrease the timer in 30 min increments (.5 hours) up to 10 hours. After 10 hours, each press of the Δ button will increase the timer in 1 hour increments up to 24 hours. Once the desired time is reached, the unit will automatically turn on.

Timer Auto Shut-Off- To program the unit to automatically turn off, press the **TIMER** button when the unit is on. Each press of the Δ or ∇ buttons will change the timer setting in 30 min increments (.5 hours) up to 10 hours. After 10 hours, each press of the Δ or ∇ buttons will increase or decrease the timer in 1 hour increments up to 24 hours. Once the desired time is over, the unit will automatically power off.

OPERATING INSTRUCTIONS

- 6) **Bucket Full** - When the water bucket is full of water, the unit will automatically shut off, make a beeping noise, and the **Bucket Full Indicator** will light up. The dehumidifier will not function until the water bucket is emptied and placed back inside the unit. The bucket should be cleaned every few weeks to prevent the growth of mold, mildew and bacteria. Use a mild detergent to clean the bucket. Once clean, completely dry the bucket and place it back inside the dehumidifier.

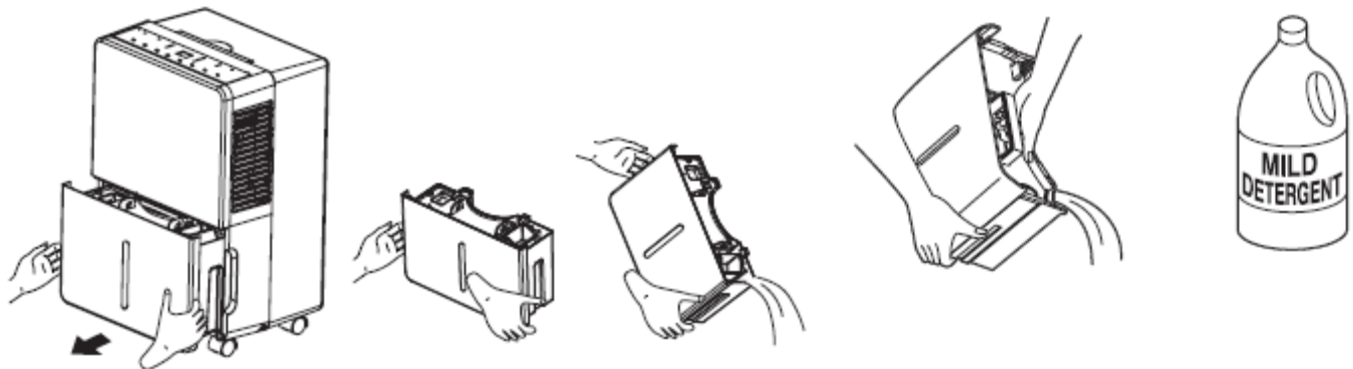

NOTE: Hold bucket with both hands when emptying.

NOTE: When the bucket is full or removed from the machine, the compressor will turn off, but the fan will continue to run for a few minutes. This is completely normal. The dehumidifier will not be removing moisture from the air at this time.

NOTE: When removing moisture from the air, the dehumidifier will exhaust warm air from the side exhaust vent.

NOTE: Do not place a full bucket on the floor, because the bottom is uneven.

OPERATING INSTRUCTIONS

- 7) **Clean Filter** - When the filter needs to be cleaned, the filter indicator will light up (after 250 hours of use). Remove the filter from the back of the unit by using your thumbs to press down on the filter tabs directly above the filter. Clean the filter with warm, soapy water. Dry thoroughly before replacing the filter. Once the filter is completely dry, place the filter back in the unit and press the **FILTER** button to reset the filter indicator.

CAUTION: DO NOT OPERATE THE DEHUMIDIFIER WITHOUT THE INCLUDED FILTER

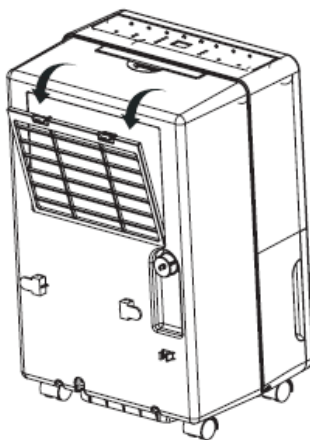

NOTE: Do not clean filter in dishwasher

- 8) **MyHome Modes** - Preset humidity level settings allow the user to easily move the dehumidifier room-to-room and select the corresponding mode for the location in which the dehumidifier is operating for optimum performance. Press the **MODE** button to choose from Sleeping Space, Living Space or Basement.
- 9) **Child-Lock Mode**- To lock the control panel, press and hold the **TIMER** button for 3 seconds. Locking the control panel prevents someone from accidentally changing the settings. When locked, the **LOCK Indicator** will light up. Press and hold the **TIMER** button for 3 seconds to unlock the control panel.
- 10) **Internal Pump Mode**- The internal pump allows the unit to operate without having to empty the bucket. To install the Pump Drain Hose Kit, remove the drain cap on the back of the unit. Insert the included Gasket into the Drain Adapter, force the Drain Hose onto the Drain Adapter and turn clockwise onto the garden hose nozzle on the back of the unit as pictured below. Once securely installed, lead the Drain Hose to a nearby drain, sink or out of a window up to 16' in height from the base of the unit. Turn on the unit and press the **PUMP** button to activate the internal pump.

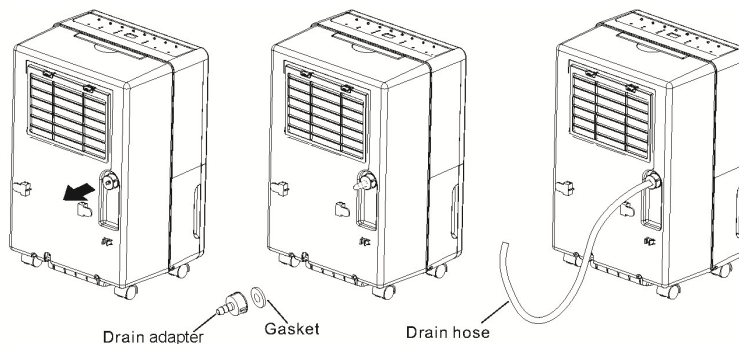

CHOOSING A LOCATION

A Dehumidifier operating in a basement will have little or no effect in drying out an adjacent enclosed storage area, such as a closet, unless there is adequate circulation of air in and out of the area.

- Do not use outdoors.
- This dehumidifier is intended for indoor use only. Place the dehumidifier on a smooth, level floor surface that is strong enough to support the unit with a full bucket of water.
- Allow at least 12"-18" of air flow on all sides.
- Place the dehumidifier in an area where the temperature will not fall below 41°F. The coils can become covered with frost at temperatures below 41°F, which may reduce performance.
- Use the dehumidifier in cooking, laundry, bathing and dishwashing areas that have excessive moisture. NOTE: Place the dehumidifier away from a clothes dryer.
- Use the dehumidifier to prevent moisture damage anywhere books or valuables are stored.
- Use the dehumidifier in a basement to help prevent moisture damage.
- The dehumidifier must be operated in an enclosed area to be most effective.
- Close all doors, windows and other outside openings to the room.

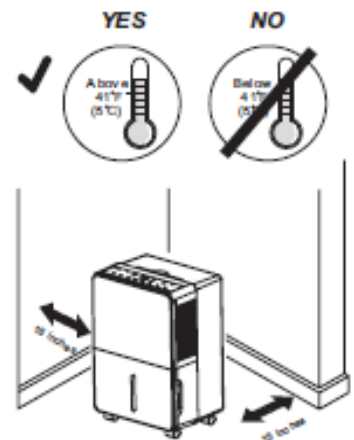

AUTOMATIC DEFROST

When frost builds up on the evaporator coils, the compressor will cycle off and the fan will continue to run until the frost disappears. When the coils are completely defrosted, the compressor or fan (depending on the model) will automatically restart and dehumidification will resume.

CONTINUOUS MODE—GARDEN HOSE INSTALLATION AND SETUP

(See page 9 for Internal Pump Mode Installation)

Water can be automatically emptied by attaching a hose to the continuous drainage port on the back of the dehumidifier. This will allow the unit to run continuously (depending on the selected humidity level) without having to empty the water bucket. To drain, simply attach a standard garden hose (not included). The thread standard for garden hoses in the US and its territories is known as GHT or "garden hose thread" which has an outer diameter of 1 1/16 inches (1.0625 inches or 27.0 mm) and a pitch of 11.5 TPI.

- Place dehumidifier on a level surface.
- Unscrew the cap on the back of the unit to access the garden hose nozzle
- Thread a garden hose (not supplied) onto the accessible nozzle, lead to a floor drain and cut to length. Make sure that there are no kinks or knots in the garden hose. (See Picture Below)
- Turn on the unit and press the MODE button until set to CONTINUOUS.

Garden Hose Installation Reference Guide

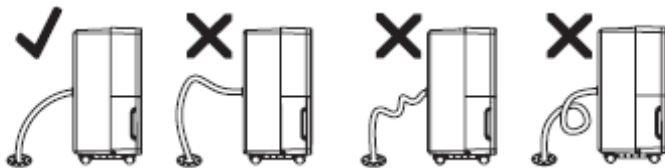

IMPORTANT NOTES:

Placing the dehumidifier on an uneven surface or improper hose installation may result in water filling up the bucket and causing the unit to shut off. Empty bucket if shut-off occurs, then check dehumidifier location and hose for proper setup. The bucket must be in place and securely seated for the dehumidifier to operate.

MAINTENANCE

Note: Make sure power is off and the power cord is not plugged into an electrical outlet prior to performing any maintenance on the unit.

Clean or Replace Filter - Refer to Page 9 Operating Instructions Clean Filter section.

Clean the Unit Housing -

- 1) Keep the unit from being exposed directly to the sun to prevent color fading.
- 2) Clean the surface with a damp cloth and dry it with a soft towel.

Storing the Unit for an Extended Period of Time or Transporting the Unit

- 1) Clean or replace filter - Refer to Page 9 Operating Instructions Clean Filter section.
- 2) Unplug the unit.
- 3) Empty any excess water (Fig.1):
 - a. Remove bucket from the unit.
 - b. Unplug the water drainage stopper inside the unit and empty any excess water.
 - c. Once the excess water is emptied, re-plug the drainage stopper.
- 3) The unit should be stored in a cool dry place.

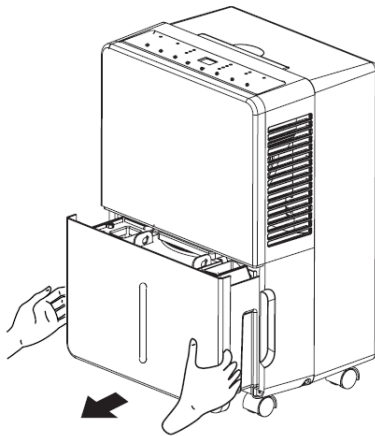
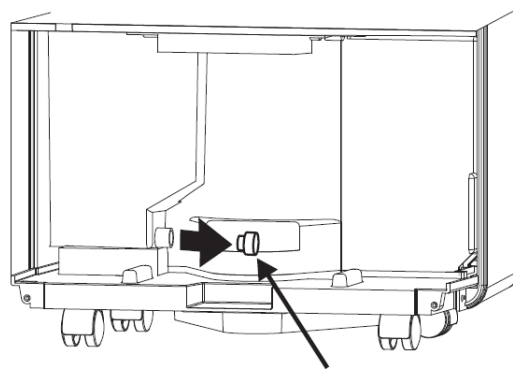

Fig.1



Drainage stopper

DISCLAIMER

ALL INFORMATION AND THE TECHNICAL SPECIFICATIONS PRESENTED IN THIS USER'S MANUAL ARE THE PRESENTATION OF THE MANUFACTURER. SOLEUS HOME COMFORT HAS NOT CONDUCTED INDEPENDENT TEST TO THE INFORMATION AND THE SPECIFICATIONS PRESENTED HEREWITHIN.

TROUBLESHOOTING

Problem	Possible Causes	Solutions
Dehumidifier does not start	The dehumidifier is unplugged.	Make sure the dehumidifier's plug is pushed completely into the outlet.
	The fuse is blown / circuit breaker is tripped.	Check the house fuse / circuit breaker box and replace fuse or reset breaker.
	Dehumidifier has reached its present level or the bucket is full.	The dehumidifier automatically turns off when either condition occurs. Change to a lower setting or empty the water bucket and replace properly.
	Bucket is not in the proper position.	The bucket must be in place and securely seated for the dehumidifier to operate.
	Power Failure.	There is a protective time delay (up to 3 min.) to prevent tripping of the compressor overload. For this reason, the unit may not start normal dehumidification for 3 min. after it is powered back on.
Dehumidifier does not dry the air as it should	Not enough time allowed for unit to remove moisture.	When first installed, allow at least 24 hours to maintain the desired dryness.
	Airflow is restricted.	Make sure there are no curtains, blinds, or furniture blocking the front or back of the dehumidifier. See the CHOOSING A LOCATION section on Page 10 .
	Dirty filter.	See the CLEAN FILTER section on Page 9 .
	The Humidity Control may not be set low enough.	For drier air, press the ▽ button to lower the percent humidity desired in the room, or set the dehumidifier to CO for maximum dehumidification.
	Doors and windows may not be closed tightly.	Check that all doors, windows, and other openings are securely closed.
	Clothes dryer may be blowing moist air into the room.	Install the dehumidifier away from the dryer. The dryer should be vented outside.
	Room temperature is too low.	Moisture removal is best at higher room temperatures. Lower room temperatures will reduce the moisture removal rate. This model is designed to operate at temperatures above 41°F.
Dehumidifier runs too much	The area to be dehumidified is too large.	The capacity of your dehumidifier may not be adequate for the room size.
	Doors and windows are open.	Close all doors and windows to the outside.
Frost appears on the coils	The dehumidifier has recently been turned on or the room temperature is below 41°F.	This is normal. Frost will usually disappear within 60 minutes.
Controls cannot be set	The compressor will turn off and the fan will automatically continue to run for approximately 3 minutes at a fixed setting.	This is normal. Wait approximately 3 minutes and set the fan speed at the desired level.
Fan Noise	Air is moving through the unit.	This is normal.
Water on the floor	Hose connection may be loose.	Check the hose connection. See the CONTINUOUS MODE-GARDEN HOSE INSTALLATION AND SET UP Section on Page 10 .
	Hose is attached but not draining into a drain	Disconnect the hose if using the bucket or place the hose near a drain.

WARRANTY

One Year Limited Warranty

Soleus Home Comfort warrants the accompanying Soleus Air Fueled by TCL Dehumidifier to be free of defects in material and workmanship for the applications specified in its operation instruction for a period of ONE (1) year from the date of original retail purchase in the United States.

If the unit exhibits a defect in normal use, Soleus Home Comfort will, at its option, either repair or replace it, free of charge within a reasonable time after the unit is returned during the warranty period.

As a condition to any warranty service obligation, the consumer must present this Warranty Certificate along with a copy of the original purchase invoice.

THIS WARRANTY DOES NOT COVER:

- Damage, accidental or otherwise, to the unit while in the possession of a consumer not caused by a defect in material or workmanship.
- Damage caused by consumer misuse, tampering, or failure to follow the care and special handling provisions in the instructions.
- Damage to the finish of the case, or other appearance parts caused by wear.
- Damage caused by repairs or alterations of the unit by anyone other than those authorized by Soleus Home Comfort.
- Freight and Insurance cost for the warranty service.
- Filter and Accessories

ALL WARRANTIES, INCLUDING ANY IMPLIED WARRANTY OF MERCHANTABILITY ARE LIMITED TO ONE-YEAR DURATION OF THIS EXPRESS LIMITED WARRANTY. **SOLEUS HOME COMFORT** DISCLAIMS ANY LIABILITY FOR CONSEQUENTIAL OR INCIDENTAL DAMAGES AND IN NO EVENT SHALL SOLEUS HOME COMFORT'S LIABILITY EXCEED THE RETAIL VALUE OF THE UNIT FOR BREACH OF ANY WRITTEN OR IMPLIED WARRANTY WITH RESPECT TO THIS UNIT.

This warranty covers only new products purchased from our authorized dealers or retailers. It does not cover used, salvaged, or refurbished products.

As some states do not allow the limitation or exclusion of incidental or consequential damages, or do not allow limitation on implied warranties, the above limitations and exclusions may not apply to you. This warranty gives you specific legal rights, and you may also have other rights that vary from state to state.

For Technical Support and Warranty Service

Please Call (888) 876-5387

Or Write To:

Soleus Home Comfort
17911 East Ajax Circle
City of Industry, CA 91748
www.soleushomecomfort.com