

Honeywell

Dehumidifier and Smart Dehumidifier User Manual

Read and save these instructions before use

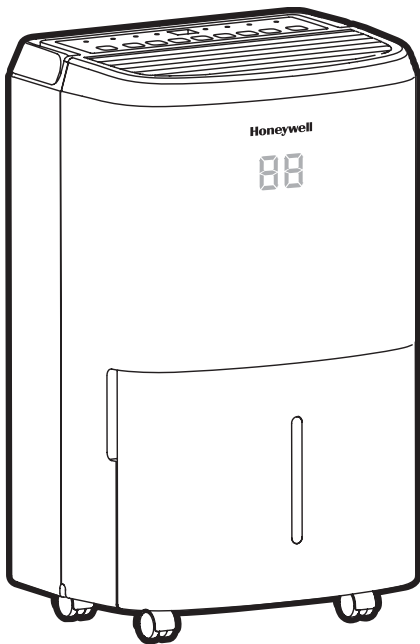

Model:

TP30WK / TP30WKN / TP30AWKN /
TP50WK / TP50WKN / TP50AWKN /
TP70WK / TP70WKN / TP70AWKN /
TP70PWK / TP70PWKN

SMART DEHUMIDIFIER WITH WIFI CONNECTIVITY & VOICE CONTROL

For Models: TP30AWKN/ TP50AWKN/ TP70AWKN Smart Dehumidifier with WiFi Connectivity

The Smart Dehumidifier has added features to allow you to operate the dehumidifier remotely using a smart device, and to use voice commands through an Amazon Echo device, to control the unit.

Set up the Honeywell Air Comfort App on your smart phone or tablet to connect the Honeywell Smart Dehumidifier for WiFi and Voice control (only available for Smart Dehumidifier models).

1. Download the Honeywell Air Comfort App User Manual from the below link:



<https://honeywellhomecomfort.com/TP-SmartApp-Manual.pdf>

2. Download the Honeywell Air Comfort App on your smart phone or tablet.



iOS 9.0 or later



Android 4.3 or later



Q SEARCH "HONEYWELL AIR COMFORT"

IMPORTANT: A 2.4 GHz Wi-Fi network is required for proper connection and operation between the Dehumidifier and the App. Other networks should be deleted, as they can interfere with connectivity.

NOTE: The Smart Dehumidifier does not have to be connected to the Honeywell Air Comfort App to function. You can still operate manually using the unit's control panel.

Thank you for purchasing a Honeywell Dehumidifier. This User Manual is intended to provide you with important information needed to set up, operate, maintain and troubleshoot this product.

SAFETY RULES

WARNING -- READ AND SAVE THESE INSTRUCTIONS BEFORE USING THIS PRODUCT.

The use of electrical products may create hazards that include, but are not limited to injury, fire, electrical shock. Failure to follow these instructions may damage and/ or impair its operation and void the warranty. In case there is any inconsistency or conflict between the English version and any other language version of the content of this material, the English version shall prevail.

When using electrical appliances, basic safety precautions should always be followed:

- DO NOT touch the dehumidifier or the electrical plug with wet hands.
- Check the household voltage to ensure it matches the appliance's specification.
- Before operating, remove all packaging material and check for any damage that may have occurred during shipping.
- DO NOT operate any product with a damaged cord or plug.
- DO NOT use an extension cord with this appliance.
- DO NOT run power cord under carpeting, or cover it with rugs or runners. Keep the cord away from areas where it may be tripped over.
- Always power off and unplug the dehumidifier before emptying the water tank.
- The water collected in the tank must be discarded. The water should never be used for drinking.
- Always unplug the dehumidifier and remove the water from the water tank before cleaning, servicing or relocating the unit.
- Remove the power cord from the electrical receptacle by grasping and pulling on the power cord plug-end only, never pull the cord.
- This appliance has been manufactured for use in domestic environments and must not be used for other purposes.
- DO NOT use the product in areas where gasoline, paint or other flammable goods and objects are used or stored.
- This dehumidifier is designed for indoor residential applications only. It should not be used for commercial or industrial applications.
- DO NOT attempt to repair or adjust any electrical or mechanical functions of the dehumidifier, as this may cause danger and void the warranty.
- DO NOT cover the air inlet or outlet on the appliance as this may cause the unit to fail.
- DO NOT insert or allow objects to enter any ventilation or exhaust opening as this may damage the product and could cause electrical shock or fire.

SAFETY RULES (CONTINUED)

- DO NOT let children play with this appliance, packaging or included plastic bag.
- If the unit is damaged or it malfunctions, do not continue to operate it. Unplug the product from the electrical outlet. Refer to the troubleshooting section and contact the customer support center.
- Always place the dehumidifier on a leveled floor.
- Never install the product near a bathtub or any water container.
- Store in a dry area, away from direct sunlight, when not in use.
- This appliance and its packaging materials are not intended for use by persons (including children or elderly) with reduced physical, sensory or mental capabilities, or lack of experience and knowledge, unless they have been given supervision or instructions concerning the use of the appliance by a person responsible for their safety.
- Always grip the top handle and keep the unit upright when transporting from room to room – DO NOT tilt the product on its side or upside-down.
- If the dehumidifier was transported tilted on its side, you must position it upright again and wait at least 4 hours before using it.
- **WARNING:** To reduce the risk of fire or electric shock, do not use this appliance with any solid state speed control device.

HOW A DEHUMIDIFIER WORKS

When the dehumidifier is switched ON, a fan pulls moisture-laden air into the dehumidifier where it passes through dehumidifying coils inside the unit. These coils condense moisture from the air and collect it in the water tank. The dry air is then exhausted from the dehumidifier. The air flows through the air vents of the dehumidifier into the room as dry, warm air.

IMPORTANT: The dehumidifier is designed to operate between 41°F (5°C) and 89°F (32°C). The dehumidifier's performance may be greatly reduced if room temperature is beyond this temperature range.

SELECTING A LOCATION - IMPORTANT

- Before using the dehumidifier, place the unit UPRIGHT for at least 4 hours before use to allow the refrigerant to stabilize in case it was transported on its side or upside-down.
- For optimal efficiency, the dehumidifier must be operated in an enclosed area. Keep all doors, windows and other outside entrances to the room closed.

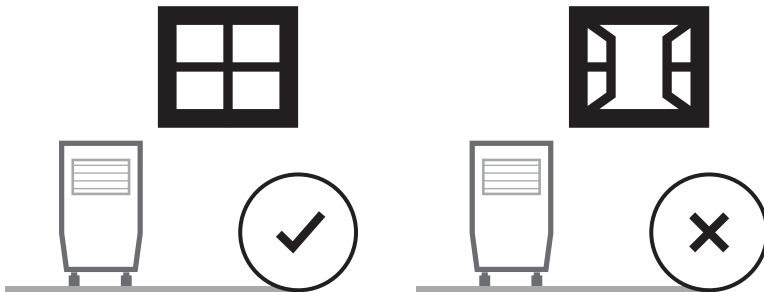

SELECTING A LOCATION - IMPORTANT (CONTINUED)

- Place the dehumidifier in an area where the temperature will not drop below 41°F (5°C)
- Place the dehumidifier at least 17.7 inches (45 cm) away from other objects (e.g. curtains or furniture) that may restrict airflow from the back or through the air vents of the unit.
- The dehumidifier must be positioned on a level floor.

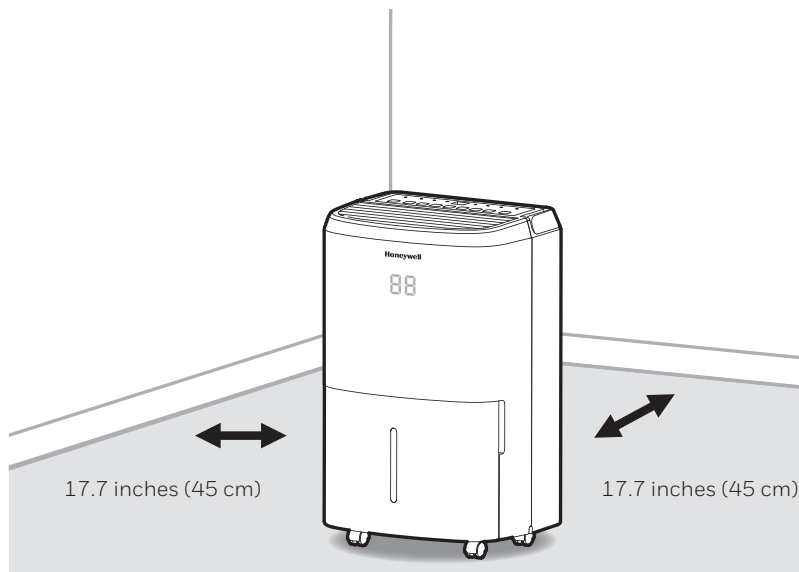

IMPORTANT: The effectiveness of the dehumidifier can be influenced by different factors. One factor is the rate at which new, moisture-laden air enters the room and the amount of air circulating in and out of the area to be dehumidified. For example, if a door to a basement is constantly opened, letting new, moisture-laden air into the room, dehumidification will take longer than if the door was kept closed. If the dehumidifier is in a room with a storage closet or cabinets, it will have little or no effect in drying the inside of the storage closet or cabinets unless there is adequate circulation of air in and out of these spaces. To dehumidify these spaces, open the storage door or cabinet doors to allow air circulation. You may find that installing a second dehumidifier may be required for larger enclosed areas.

UNPACKAGING THE DEHUMIDIFIER

- This Dehumidifier is packaged with a colored or transparent tape to secure some parts during transportation. Remove the colored or transparent packaging tape from the unit.

1. Gently pull the water tank from out of the dehumidifier
2. Remove the splash guard from the top part of the water tank
3. Take out the power plug, drain hose and other accessories, which is placed inside the tank of the dehumidifier.
4. Once all accessories have been removed, replace the splash guard onto the top part of the water tank. Make sure that the tank is properly positioned.

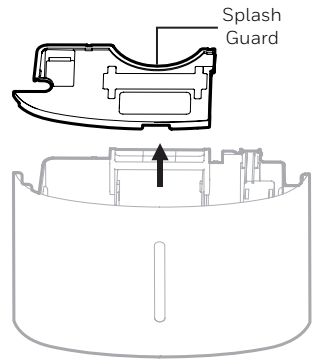

- There is a Foam Float inside the water tank that senses the water level to automatically stop dehumidification when the water tank is full. Make sure the Foam Float is positioned correctly inside the water tank by ensuring it lies level with the top edge of the water tank.

DO NOT REMOVE THIS FOAM FLOAT.

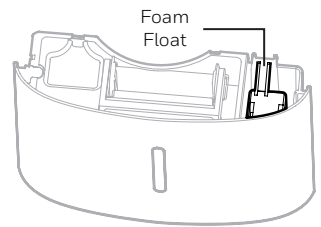

PARTS DESCRIPTION

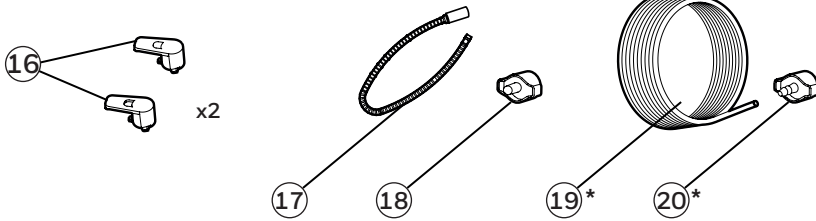
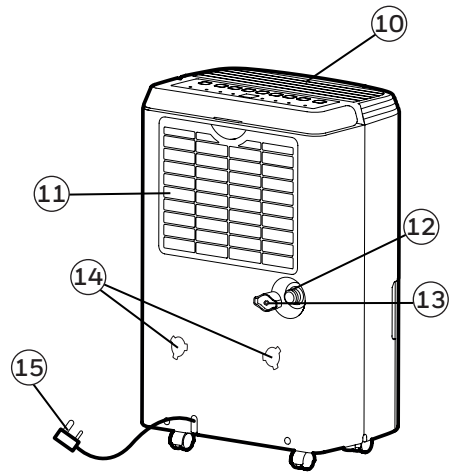
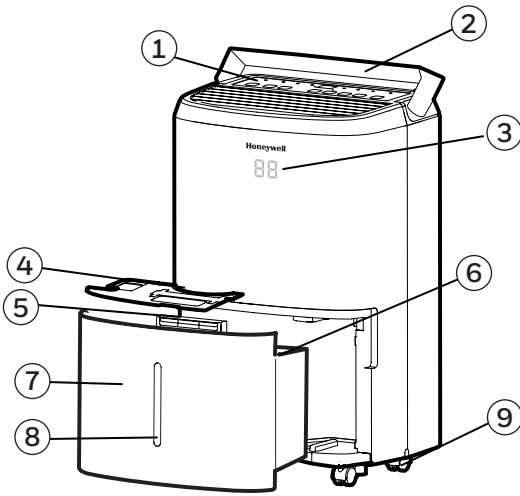

- | | |
|--------------------------|--|
| 1) Control Panel | 10) Dehumidified Air Exhaust Vent |
| 2) Handle | 11) Washable Dust Filter |
| 3) LED Display | 12) Direct Drain Outlet |
| 4) Splash Guard | 13) Direct Drain Cap |
| 5) Water Tank Handle | 14) Mounting Holes for Cord Winders |
| 6) Foam Float | 15) Power Cord & Plug |
| 7) Water Tank | 16) Cord Winders |
| 8) Water Level Indicator | 17) Continuous Water Drain Tube
(Inner Dia.: 0.47 inch; Length: 3.28 ft.) |
| 9) Casters | 18) Continuous Water Drain Cap |

*** THIS IS ONLY FOR MODEL TP70PWK / TP70PWKN WITH BUILT-IN DRAIN PUMP**

- | | |
|---|-------------------------|
| 19) Auto Drain Pump Tube
(Inner Dia.: 0.21 inch; Length: 16.4 ft.) | 20) Auto Drain Pump Cap |
|---|-------------------------|

INSTALL THE CORD WINDER

Once you have removed the cord winder accessories from the water tank - follow the steps below.

Step 1: Line up the cord winder pieces to the mounting holes.

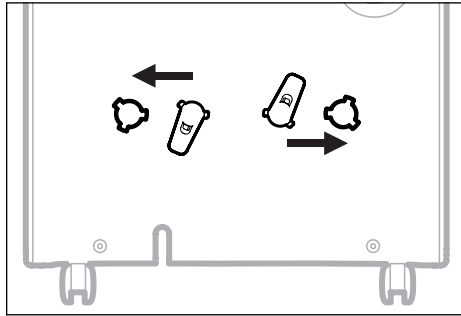

Step 2: Rotate 45-degrees clock-wise.

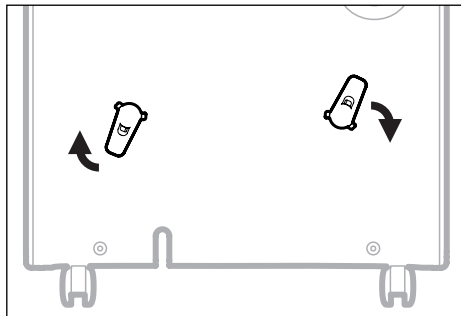

Step 3: Once you hear "click", then you know the cord winder is ready for use.

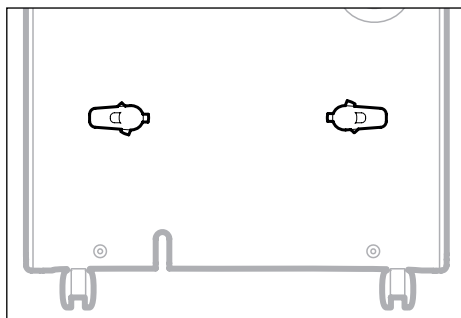

NOTE: Once the installation of the cord winder has been completed. The cord winder cannot be removed. The installation is permanent.

CONTROL PANEL

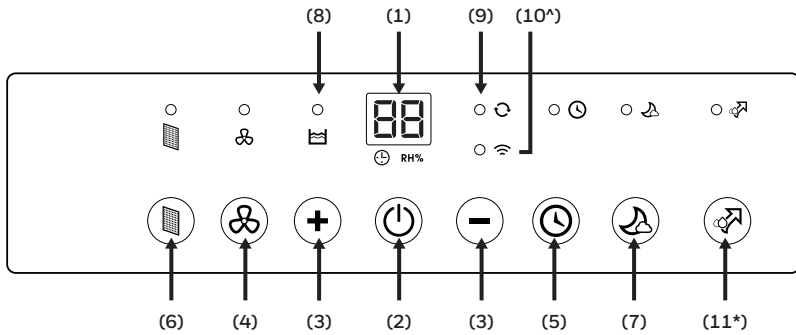

- | | |
|----------------------------------|-------------------------------|
| 1) Display Screen | 6) Filter Alert |
| 2) Power Control | 7) Sleep Mode |
| 3) Humidity / Timer Set Controls | 8) Water Full Indicator Light |
| 4) Fan Speed Control | 9) Continuous Operation Light |
| 5) Timer Control | |

10^*) Wi-Fi Connectivity and Voice Activated Control

^ THIS IS ONLY FOR MODEL TP30AWKN / TP50AWKN / TP70AWKN WITH WIFI SMART FEATURES

NOTE: For detailed instructions to set up your dehumidifier for connected operation from your smart phone or tablet, separate user manual can be downloaded at:



<https://honeywellhomecomfort.com/TP-SmartApp-Manual.pdf>

11*) Auto Drain Pump Mode

***THIS IS ONLY FOR MODEL TP70PWK / TP70PWKN WITH BUILT-IN DRAIN PUMP**

FUNCTION BUTTONS

POWER CONTROL

Press  to switch the dehumidifier ON or OFF.

HUMIDITY CONTROL SETTING



When the unit is switched ON, the Display Screen shows the current humidity percentage.



Press **+** or **-** to select your preferred humidity level. The humidity is adjusted in increments of 5% by pressing **+** or **-**. The adjustable Relative Humidity (RH) range is between 30% RH to 90% RH. Ten seconds after setting the preferred humidity setting, the display will revert back to displaying the current humidity.

IMPORTANT: There is a 5% threshold when the desired humidity setting has been reached. The compressor will shut off once the relative humidity is 5% lower than your desired setting. The fan will continue to run for up to 3 minutes to cool the motor and will then shut off. Operation restores once the relative humidity is 5% higher than your desired setting.

Recommended Settings: It is recommended to leave the unit running at 30% humidity at High Fan Speed during the first 2 to 3 days until damp odors are removed. After a few days when the Relative Humidity has been reduced to a more comfortable level, press **+** or **-** to choose a higher RH% that maintains a comfortable humidity level thereafter. A recommended healthy humidity level is between 40% and 50%.



NOTE: The humidity sensor senses current humidity in the surrounding area. It is normal for about a 5% variance above or below the actual relative humidity in the room. Therefore, if there is a slight variance, the unit may sometimes operate slightly longer or shorter than the set RH% level.

CONTINUOUS MODE

To activate the Continuous Mode, press the **-** button on the Display Screen until  appears. The  indicator light will be illuminated. The unit will run continuously.

FUNCTION BUTTONS (CONTINUED)

WATER TANK FULL ALERT

When the Water Tank is full, the  indicator will be illuminated. The unit will beep for 3 seconds. The compressor will shut off, and the fan will stop for a few minutes. To switch off the  indicator light, empty the water tank and when replacing it ensure the tank is secured properly in place.



IMPORTANT: Do not place the Water Tank on the floor when full. In case of an uneven base which may cause the tank to spillover.

TIMER CONTROL



The dehumidifier can be set to automatically switch ON or OFF for a selected period of time (between 0.5-24 hour intervals). The Timer hours selection is displayed on the Display Screen.

NOTE: Before setting the Timer control, make sure there is power to the unit.

Auto-Off Timer:

While the unit is running, press , the timer  indicator light will flash, press **+** or **-** to select the number of hours (0.5-24 hours) you want the unit to run before it switches off. In 5 seconds without the operation, the Timer start function, the timer  indicator light is illuminated. Timer must be set again after each use.



Auto-On Timer:

When unit is in Standby Mode, press , the timer  indicator light will flash, press **+** or **-** to select the number of hours (0.5-24 hours) until you want the unit to automatically start running. In 5 seconds without the operation, the Timer start function, the timer  indicator light is illuminated. The previous fan speed and humidity setting will be maintained. The unit will turn on and continue running until the water tank is full (unless the unit is set up for continuous draining) or until you switch it off manually. Timer must be set again after each use.

NOTE: To cancel any Timer settings, simply press  again, and the timer  indicator light will disappear.

NOTE: The solid red Power light indicates the unit is on Standby Mode.

FAN SPEED CONTROL

There are two fan speeds - High and Low. When, the  indicator light is illuminated, the unit is operating on High speed. When the  indicator light is off, and the unit is on - the unit is operating on Low speed.



FUNCTION BUTTONS (CONTINUED)

FILTER ALERT

When the Filter Alert Light is ON, it is time to clean the filter. Switch the unit OFF and carefully remove the filter from the unit and clean. Replace the filter, switch on the unit and reactivate the Filter Alert button by pressing it once.

The Filter Alert Light should not be illuminated until the filter requires cleaning again. The frequency of filter cleaning depends on room environment conditions. Some rooms may require changing more frequently than others.

SLEEP MODE



The LED display brightness will be reduced when the unit is in Sleep Mode. Press the  to activate the Sleep Mode. When Sleep Mode is activated the  indicator light will be illuminated. There is a one-minute window period in which you can adjust the settings such as humidity and fan speed. After one minute has lapsed, the top display will shut off, except the  indicator light. Press any button to deactivate Sleep Mode.

WI-FI MODE[^]

When the Smart Dehumidifier is connected to the wifi function, the  indicator light will be illuminated.

[^] THIS IS ONLY FOR MODEL TP30AWKN / TP50AWKN / TP70AWKN WITH WI-FI SMART FEATURES

AUTO DRAIN PUMP MODE*

The Auto Drain Pump function helps to remove condensation vertically and horizontally. Press the  to activate the Pump function, the  indicator light will be illuminated.

*THIS IS ONLY FOR MODEL TP70PWK / TP70PWKN WITH BUILT-IN DRAIN PUMP

PUMP DOES NOT AUTO-RESTART AFTER POWER FAILURE

WARNING: For models with Auto Drain Pump, the Auto Drain Pump will not automatically restart after a power outage to prevent leakage in case the drain tube was disconnected during power failure. The Auto Drain Pump Mode button must be manually reactivated in the event of a power outage.

AUTOMATIC DEFROST

Frost may build up on the internal coils of the unit. When there is frost build up, the internal compressor will turn off and the fan will continue to run until the frost has melted. Once the internal coils have defrosted and dried, the compressor or fan will automatically restart and dehumidifying will resume.

DRAINING THE WATER



WARNING: Always drain and discard water collected from dehumidification. The water is not clean and cannot be used for drinking.

1. Draining water collected in the Water Tank

The condensed water can be collected directly into the water tank. When the water tank is full, the dehumidifier will automatically shut OFF and the  indicator will illuminate on the control panel followed by a beeping sound.

IMPORTANT: Do not move the dehumidifier when the Water Tank is full as it will be heavy and can cause water spillage.

1.1 Locate the water tank at the front of the dehumidifier.

Gently pull the water tank out.

1.2 Grip the handle inside the water tank and carry the water tank to a sink to empty.

1.3 Replace the empty water tank back into the front of the dehumidifier. Please make sure that the tank is properly positioned. The safety feature ensures that any misalignment of the tank and the unit will prevent the unit from turning back on.

1.1

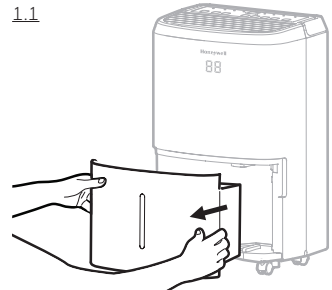

1.2

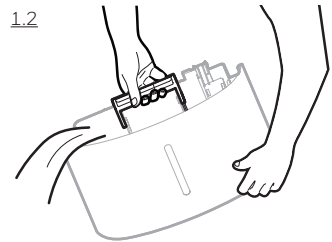

IMPORTANT: Improper alignment or positioning of the water tank will cause the unit to pause operation, the warning light on top of the dehumidifier will illuminate followed by a beeping sound, until the water tank is fitted properly.

NOTE: There is a Foam Float inside the water tank that senses the water level to automatically stop dehumidification when the water tank is full. Make sure the Foam Float is positioned correctly inside the water tank by ensuring it lies level with the top edge of the water tank.

DO NOT REMOVE THIS FOAM FLOAT.

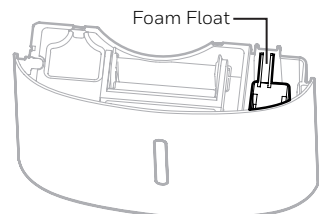

DRAINING THE WATER (CONTINUED)

2. Continuous Water Drainage – Using a Continuous Water Drain Tube

A continuous water drain tube is included with this unit. To activate the continuous water draining function, you will require a suitable water drain (e.g. sink or drain hole at floor level) near the dehumidifier.

Continuous Water
Drain Tube
3.28 ft. (1 m)

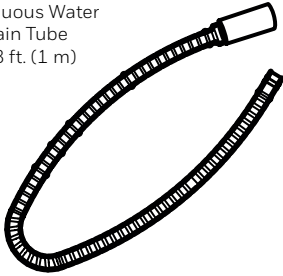

Continuous Water Drain Cap

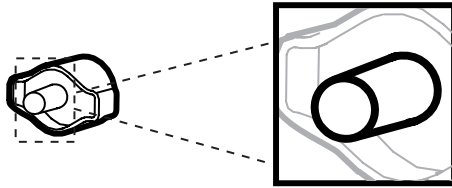

NOTE: The Continuous Drain Tube and Continuous Drain Cap come pre-installed.

- 2.1 Locate the drain outlet at the back of the unit. Unscrew and remove the Direct Drain Cap. Insert and screw the Continuous Water Drain Tube into the Direct Drain Outlet.

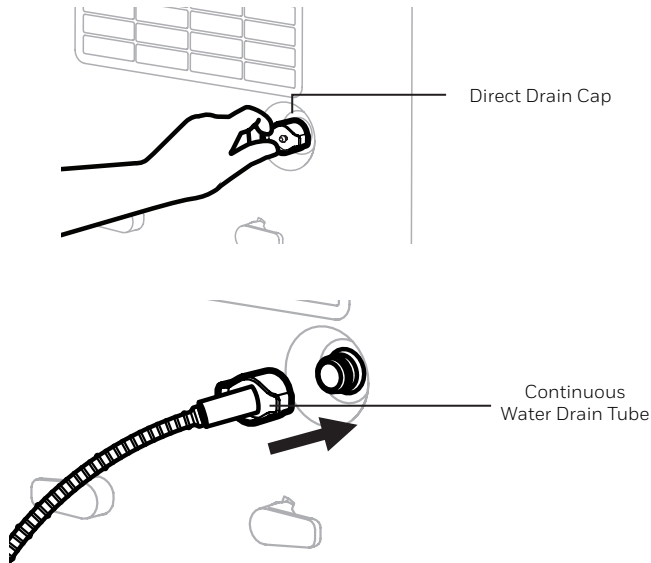

DRAINING THE WATER (CONTINUED)

2.2 If there are leaks, the Continuous Water Drain Tube and Cap may have loosened and may not be connected properly. Disconnect, replace and tighten again.

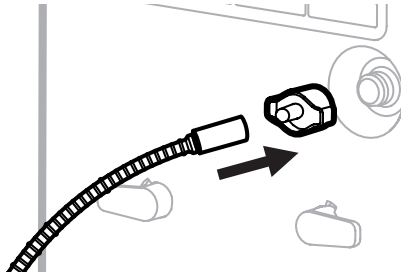

2.3 Position the other end of the Continuous Water Drain Tube in the sink or drain. Make sure the tube is not bent or kinked which might stop the water flow. Make sure the tube is secured over the drain and will not fall out of place causing unwanted water spillage.

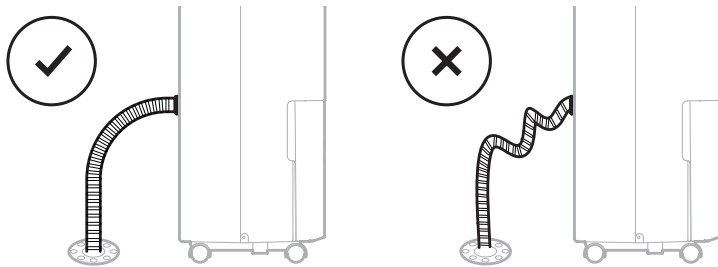

IMPORTANT: Make sure water can flow down the Continuous Water Drain Tube by keeping the tube angled down and free of bends or kinks.

IMPORTANT: If the unit is placed on uneven ground, or the Drain Tube is installed incorrectly, the water may fill the water tank and stop running. Please check whether the ground is uneven and reinstall the Drain Tube.

DRAINING THE WATER (CONTINUED)

3. Continuous Water Drainage – Using the Auto Drain Pump option

***THIS IS ONLY FOR MODEL TP70PWK / TP70PWKN WITH BUILT-IN DRAIN PUMP**

The Auto Drain Pump is available if you want to use the continuous drain function, but the drain is further away, or located above the dehumidifier. The Auto Drain Pump Tube can be attached to the Direct Drain Outlet located on the back side of the dehumidifier. When the water level in the water tank reaches a certain level, the drain pump will automatically pump the water out of the tank to the drain. This allows you to drain water condensation vertically or horizontally, even if the drain is located above the dehumidifier.

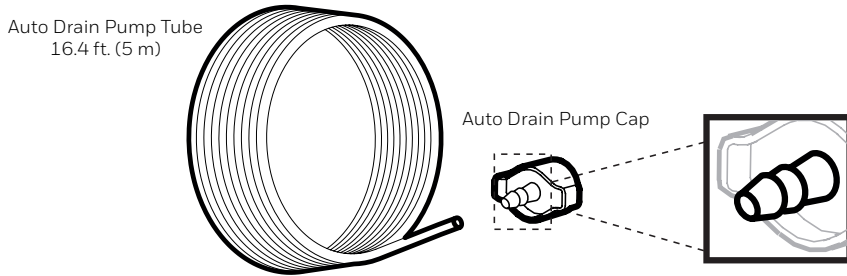

NOTE: The Auto Drain Pump Tube and Auto Drain Pump Cap come pre-installed.

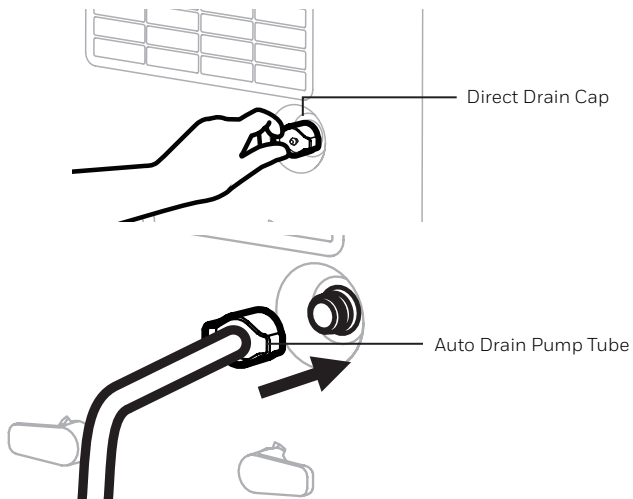

- 3.1 Locate the drain outlet at the back of the unit. Unscrew and remove the Direct Drain Cap. Insert and screw the Auto Drain Pump Tube into the Direct Drain Outlet.

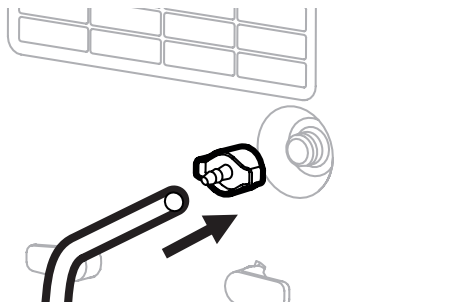

DRAINING THE WATER (CONTINUED)

- 3.2 If there are leaks, the Auto Drain Pump Tube and Auto Drain Pump Cap may have loosened and may not be connected properly. Disconnect, replace and tighten again.



- 3.3 To activate the Pump function, press the  indicator. Once on, the  indicator light will be illuminated.
- 3.5 Place the other end of the tube into the sink or drain. The water can be pumped up to 16.4 ft (5 m) vertically or horizontally.

NOTE: DO NOT use an alternative drain tube that is longer than the one provided with the unit.

IMPORTANT: The Auto Drain Pump button needs to be pressed to re-activate the auto drain pump function when there is a power failure. See section on "Auto Restart" Function of this user manual.

**Auto Drain Pump Tube is included in Dehumidifier models with Auto Drain Pump feature only.*

CLEANING & MAINTENANCE

WARNING: Always switch OFF the dehumidifier and unplug it from the electrical outlet before attempting any cleaning or maintenance of this product.

Appliance Maintenance:

- Switch OFF the appliance before disconnecting the power supply.
- Only use a soft cloth to clean the appliance.

Dust Filter Maintenance:

The Dust Filter located at the back of the unit helps to remove dust particles from the air. A dirty filter clogged by dust particles can reduce the efficiency of the dehumidifier. For optimum dehumidification, it is recommended to clean the dust filter every 2 weeks:

1. Switch off and unplug the dehumidifier from the electrical outlet.
2. Carefully pull out the dust filter from the dehumidifier.
3. Rinse the dust filter under running water, or vacuum away the dust with a vacuum cleaner.
4. After cleaning the dust filter, dry in a cool, shaded place, then carefully reinstall into the unit.

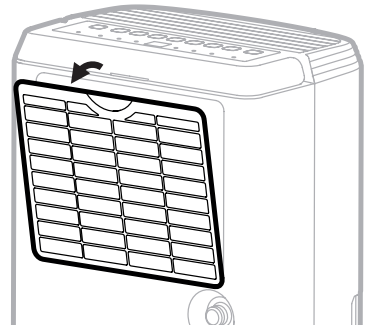

End of Season Storage & Maintenance:

If the appliance will not be used for an extended period of time:

- Switch OFF the unit and unplug from the electrical power outlet.
- Empty the water tank and let it dry. If your dehumidifier is connected to the continuous drain hose, you must disconnect the hose, dry and then replace the drain cap back into the drain outlet.
- Remove the air filter and clean with water. Let the air filter dry and reinstall back into the unit.
- Make sure all parts of the dehumidifier and accessories are dry before storage.
- Cover the dehumidifier with a cloth/ plastic bag before storage, to protect the surface from dust and scratches.
- It is recommended to coil the power cord and store it off the floor to ensure it is protected from bends and kinks.
- Store the unit upright in a dry location, away from direct sunlight.

TROUBLESHOOTING GUIDE

The following troubleshooting guide addresses the most common problems. If problems persist, call customer service.

PROBLEM	POSSIBLE CAUSE	SOLUTION
Dehumidifier does not start	No electricity.	Check for power.
	The power cord is not properly plugged in.	Remove and reconnect the power cord.
	The water tank is not in the correct position.	Position the water tank correctly into the unit. Unit will not operate until the water tank is secure in place.
Unit runs but the humidity level does not decrease	The humidity level setting is too high.	Decrease the humidity level setting.
	A door or window is open, letting in new moisture.	Make sure all windows or doors to the outside are closed and tightly sealed.
	There are other sources of humidity in the room (e.g. boiling water in pot).	Switch on the dehumidifier when these sources are not present.
	The temperature in the room is too low.	The dehumidifier is designed to operate between 41°F (5°C) and 89°F (32°C). Moisture removal is greatly reduced if room temperatures exceed this temperature range.
	The dust filter is dirty/ blocked.	Clean the dust filter.
	Air outlet or intake is blocked.	Remove blockage.

TROUBLESHOOTING GUIDE (CONTINUED)

PROBLEM	POSSIBLE CAUSE	SOLUTION
Unit runs but the humidity level does not decrease	Insufficient time for the dehumidifier to remove moisture.	After initial installation, allow 24 hours to maintain desired dryness.
Dehumidifier runs constantly/ does not stop	Area to be dehumidified is too large.	The capacity of your dehumidifier may not be adequate for the room it is used in. It is recommended to add an extra dehumidifier for large areas.
	A door or window is open, letting in new moisture.	Make sure all windows or doors to the outside are closed and tightly sealed.
Water Tank Full  is illuminated and the unit is beeping	The water tank is full.	Empty the water tank.
	The water tank is not in the correct position.	Position the water tank correctly into the unit. Unit will not operate until the water tank is secure in place.
The unit is blowing cold air out of the top vent	The purpose of the top air vent is to distribute air into the room.	The temperature of the air from the vent depends on the room environment and other factors. It can fluctuate and this is normal. No action required.
Frost appears on the coils	Dehumidifier has been recently turned on in low room temperatures (usually below 41°F (5°C)).	This is normal. Frost will disappear in an hour or so after the dehumidifier is switched OFF.
Connected the continuous drain but the water condensation is not draining out the tube	Some floors may have an uneven surface which may affect the continuous drainage function	Raise the front of the Dehumidifier ½ to 1 inch (1.27 cm to 2.54 cm) from the floor. The water condensation will drain out the back hose and not into the bucket.

TROUBLESHOOTING GUIDE (CONTINUED)

PROBLEM	POSSIBLE CAUSE	SOLUTION
Water on the floor	The garden hose/ drain hose may be loose.	Check the connections between the hose and the drain outlet on the unit. See Continuous Water Drainage section.
	You intended to use the water tank to collect water but the continuous drain hose is still connected.	Disconnect the hose and replace the rubber stopper and drain cap if using the water tank to collect water. See Continuous Water Drainage section.
Noise	Fan is working.	Wind from the fan can create sounds during operation. This is a normal sound.
	Compressor is working.	There is a sound when the compressor turns on. The compressor will activate periodically based on humidity settings. This is normal.

ERROR CODE GUIDE

CODE	POSSIBLE CAUSE	POSSIBLE SOLUTIONS
P1	Water tank not installed or positioned correctly	This only appears for model TP70PWK / TP70PWKN with Built-in Drain Pump. Position the water tank correctly into the unit. Unit will not operate until the water tank is secured in the correct position.
EH	Humidity sensor failure	Please contact the service center.
E1 / E2	Temperature sensor failure	Please contact the service center.
E3	Refrigeration System Protection	<p>If E3 appears, check if the ambient room temperature has exceeded 89.6°F (32°C). If yes, the unit may not run until the room ambient temperature has reduced to below 86°F (30°C) for at least 2 hours, or try to remove the unit to a cooler room for at least 2 hours before running dehumidification mode again.</p> <p>If the E3 appears again in 2 hours, please contact the service center.</p>
E5	Auto-Drain Pump failure	<p>Check that Auto Drain Pump Tube and Auto Drain Pump Cap is connected and properly installed onto the Drain Outlet.</p> <p>Check that the Direct Drain Outlet is clean and not jammed by sediments collected on and around the outlet.</p> <p>Check that the dehumidifier Direct Drain Outlet is positioned higher than the Auto Drain Pump Tube. The bucket or drain hole that collects the condensation should always be lower than the Drain Outlet for the water to flow downwards into the drain bucket.</p> <p>Check to see that the correct Auto Drain Tube is being used (the dehumidifier comes with a 5m long Auto Drain Pump Tube. The tube should not be longer than 5m.</p> <p>Check that the Auto Drain Pump Cap is securely screwed onto the Drain Outlet and no leakage is occurring due to unsecure connection.</p> <p>Please contact the Customer Service Center if error code persists after doing the above checks.</p>

REGULATION STATEMENT

FCC INTERFERENCE STATEMENT

This device complies with part 15 of the FCC Rules. Operation is subject to following two conditions:

- (1) this device may not cause harmful interference, and
- (2) this device must accept any interference received, including interference that may cause undesired operation.

This equipment has been tested and found to comply with the limits for a Class B digital device, pursuant to part 15 of the FCC Rules. These limits are designed to provide reasonable protection against harmful interference in a residential installation. This equipment generates, uses and can radiate radio frequency energy and, if not installed and used in accordance with the instructions, may cause harmful interference to radio communications. However, there is no guarantee that interference will not occur in a particular installation. If this equipment does cause harmful interference to radio or television reception, which can be determined by turning the equipment off and on, the user is encouraged to try to correct the interference by one or more of the following measures:

- Reorient or relocate the receiving antenna.
- Increase the separation between the equipment and the receiver.
- Connect the equipment into an outlet on a circuit different from that to which the receiver is connected.
- Consult the dealer or an experienced radio/ TV technician for help.

This equipment complies with FCC radiation exposure limits set forth for an uncontrolled environment. This equipment should be installed and operated with minimum 20 cm between the radiator and your body. This transmitter must not be collocated or operating in conjunction with any other antenna or transmitter unless authorized to do so by the FCC.

Caution: Any changes or modifications not expressly approved by the party responsible for compliance could void the user's authority to operate the equipment.

INDUSTRY CANADA (IC) STATEMENT

This Class B digital apparatus complies with Canadian ICES-003.

This device complies with Industry Canada license-exempt RSS standard(s). Operation is subject to the following two conditions:

- (1) this device may not cause interference, and
- (2) this device must accept any interference, including interference that may cause undesired operation of the device.

The antenna (or antennas) must be installed so as to maintain at all times a distance minimum of at least 20 cm between the radiation source (antenna) and any individual. This device may not be installed or used in conjunction with any other antenna or transmitter.



Electrical products should be properly disposed of. Please recycle where facilities exist. Check with your local authority or retailer for recycling.



ENERGY STAR® qualified units remove moisture with less energy than conventional dehumidifiers.

JMATEK North America LLC
Mahwah, New Jersey 07495 USA
Email: usinfo@jmatek.com
Web: www.jmatek.com

Made in China
© 2021 JMATEK Limited. All rights reserved.
The Honeywell Trademark is used under license
from Honeywell International Inc.
Honeywell International Inc. makes no
representations or warranties with respect to this product.
This product is manufactured by Airtel Int'l Corp. Ltd.
(subsidiary of JMATEK Ltd.).

Honeywell