

DEHUMIDIFIER

Keystone®

~~OWNER'S MANUAL~~ OWNER'S MANUAL



Model: KSTAD224E
KSTAD354E
KSTAD504E
KSTAD506PE

Before operating this product, please read the instructions carefully and save this manual for future use.



Tarjeta de Registracion de Producto

Es sencillo! Cumple y envia su Tarjeta de Registracion de Producto hoy!

Nombre

Dirección

Ciudad Estado Código postal

Teléfono (Opcional) / -

Dirección de E-mail (Opcional)

Donde Comprado

Numero de Modelo Numero de Serie Mes Dia Año

REV 11/04 Fecha de la compra

Participar devuelve su Tarjeta de Registracion de Producto hoy!



Product Registration Card

It's simple! Complete and mail your Product Registration Card today!

Name

Address

City State Zip

Phone (Optional) / -

E-mail Address (Optional)

Where Purchased

Model Number Serial Number Month Day Year

REV 11/04 Date of Purchase

Please return your Product Registration Card today!



PLACE
STAMP
HERE

Postage
Required:
Post Office Will
not deliver
without proper
postage.





Product Warranty Card

Tarjeta de Garantia de Producto

Air conditioner warranty

Your product is protected by this warranty:
Your appliance is warranted by Keystone. Any obligations for services and parts under this warranty must be performed Keystone.
To contact a Customer Service Representative, Call TOLL FREE

800-849-1112

keystonecs@keystone-products.com

Garantía

Su producto está protegido por esta garantía:
Su producto está garantizado por Keystone. Cualquier obligación de proporcionar servicio o repuestos establecida en esta garantía deberá ser cumplida por los Servicios al consumidor de Keystone.

Para comunicarse con un Representante de Servicio al Cliente, tenga la bondad de llamar por teléfono sin cargo alguno a, al número:

800-849-1112

keystonecs@keystone-products.com

SOCIABLE REMARK

When using this dehumidifier in the European countries, the following information must be followed:

DISPOSAL: Do not dispose this product as unsorted municipal waste. Collection of such waste separately for special treatment is necessary.

It is prohibited to dispose of this appliance in domestic household waste.

For disposal, there are several possibilities:

- A) The municipality has established collection systems, where electronic waste can be disposed of at least free of charge to the user.
- B) When buying a new product, the retailer will take back the old product at least free of charge.
- C) The manufacture will take back the old appliance for disposal at least free of charge to the user.
- D) As old products contain valuable resources, they can be sold to scrap metal dealers.

Wild disposal of waste in forests and landscapes endangers your health when hazardous substances leak into the ground-water and find their way into the food chain.

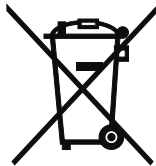

CONTENTS

SAFETY PRECAUTIONS

Warning	2
Caution	2
Electrical information	3

CONTROL PADS ON THE DEHUMIDIFIER

Control pads.....	4
Other features.....	5

IDENTIFICATION OF PARTS

Identification of parts	6
Positioning the unit	7

OPERATING THE UNIT

When using the unit	7
Removing the collected water	8

CARE AND MAINTENANCE

Care and cleaning of the dehumidifier	10
---	----

TROUBLESHOOTING TIPS

Troubleshooting tips	11
----------------------------	----

Read This Manual

Inside you will find many helpful hints on how to use and maintain your air conditioner properly. Just a little preventive care on your part can save you a great deal of time and money over the life of your air conditioner. You'll find many answers to common problems in the chart of troubleshooting tips. If you review our chart of Troubleshooting Tips first, you may not need to call for service at all.



CAUTION

- This appliance can be used by children aged from 8 years and above and persons with reduced physical, sensory or mental capabilities or lack of experience and knowledge if they have been given supervision or instruction concerning use of the appliance in a safe way and understand the hazards involved. Children shall not play the appliance. Cleaning and user maintenance shall not be made by children without supervision. (be applicable for the European Countries)
- This appliance is not intended for use by persons (including children) with reduced physical ,sensory or mental capabilities or lack of experience and knowledge, unless they have been given supervision or instruction concerning use of the appliance by a person responsible for their safety. (be applicable for other countries except the European Countries)
- Children should be supervised to ensure that they do not play with the appliance.
- If the supply cord is damaged, it must be replaced by the manufacturer, its service agent or similarly qualified persons in order to avoid a hazard.
- The appliance shall be installed in accordance with national wiring regulations.
- The appliance with electric heater shall have at least 1 meter space to the combustible materials.
- Contact the authorised service technician for repair or maintenance of this unit.



SAFETY PRECAUTIONS

To prevent injury to the user or other people and property damage, the following instructions must be followed. Incorrect operation due to ignoring of instructions may cause harm or damage.

■ The seriousness is classified by the following indications.

 WARNING	This symbol indicates the possibility of death or serious injury.
 CAUTION	This symbol indicates the possibility of injury or damage to property.

■ Meanings of symbols used in this manual are as shown below.

	Never do this.
	Always do this.

WARNING

 **Do not exceed the rating of the power outlet or connection device.**

● Otherwise, it may cause electric shock or fire due to excess heat generation.

 **Do not operate or stop the unit by switching on or off the power.**

● It may cause electric shock or fire due to heat generation.

 **Do not damage or use an unspecified power cord.**

● It may cause electric shock or fire.

 **Do not modify power cord length or share the outlet with other appliances**

● It may cause electric shock or fire due to heat generation.

 **Do not insert or pull out plug with wet hands.**

● It may cause electric shock.

 **Do not place the unit near a heat source.**

● Plastic parts may melt and cause a fire.

 **Disconnect the power if strange sounds, smell, or smoke comes from it.**

● It may cause fire and electric shock.

 **You should never try to take apart or repair the unit by yourself.**

● It may cause failure of machine or electric shock.

 **Before cleaning, turn off the power and unplug the unit.**

● It may cause electrical shock or injury.

 **Do not use the machine near flammable gas or combustibles, such as gasoline, benzene, thinner, etc.**

● It may cause an explosion or fire.

 **Do not drink or use the water drained from the unit.**

● It contains contaminants and could make you sick.

 **Do not take the water bucket out during operation.**

● It may cause bucket full protect of the unit and cause electric shock.

CAUTION

 **Do not use the unit in small spaces.**

● Lack of ventilation can cause overheating and fire.

 **Do not put in places where water may splash onto the unit.**

● Water may enter the unit and degrade the insulation. It may cause an electric shock or fire.

 **Place the unit on a level, sturdy section of the floor.**

● If the unit falls over, it may cause water to spill and damage belongings, or cause electrical shock or fire.

SAFETY PRECAUTIONS

⚠ CAUTION

ⓘ Do not cover the intake or exhaust openings with cloths or towels.

- A lack of air flow can lead to overheating and fire.

ⓘ Never insert your finger or other foreign objects into grills or openings. Take special care to warn children of these dangers.

- It may cause electric shock or failure of appliance.

ⓘ Always insert the filters securely. Clean filter once every two weeks.

- Operation without filters may cause failure.

ⓘ Be careful when you removing the filter not to damage the fins.

- It may cause failure of appliance or injure your finger.

ⓘ Care should be taken when using the unit in a room with the following persons:

- Infants, children, elderly people, and people not sensitive to humidity.

ⓘ Do not place heavy object on the power cord and take care so that the cord is not compressed.

- There is danger of fire or electric shock.

ⓘ If water enters the unit, turn the unit off and disconnect the power, contact a qualified service technician.

- It may cause failure of appliance or accident.

ⓘ Turn off the unit before remove the water bucket.

- It may cause failure of appliance.

ⓘ Do not use in areas where chemicals are handled.

- This will cause the unit deterioration due to chemicals and solvents dissolved in the air.

ⓘ Do not climb up on or sit on the unit.

- You may be injured if you fall or if the unit falls over.

ⓘ Do not place flower vases or other water container on top of the unit.

- Water may spill inside the unit, causing insulation failure and electrical shock or fire.

Electrical Information

- The manufacturer's nameplate is located on the rear panel of the unit and contains electrical and other technical data specific to this unit.
- Be sure the unit is properly grounded. To minimize shock and fire hazards, proper grounding is important. The power cord is equipped with a three-prong grounding plug for protection against shock hazards.
- Your unit must be used in a properly grounded wall receptacle. If the wall receptacle you intend to use is not adequately grounded or protected by a time delay fuse or circuit breaker, have a qualified electrician install the proper receptacle.
- Ensure the receptacle is accessible after the unit installation.
- **Do not use extension cords or an adapter plugs with this unit.** However, if it is necessary to use an extension cord, use an approved "Dehumidifier" extension cord only (available at most local hardware stores).
- To avoid the possibility of personal injury, always disconnect the power supply to the unit, before installing and/or servicing.

CONTROL PADS ON THE DEHUMIDIFIER

NOTE: The control panel of the unit you purchased may be slightly different according to the models.

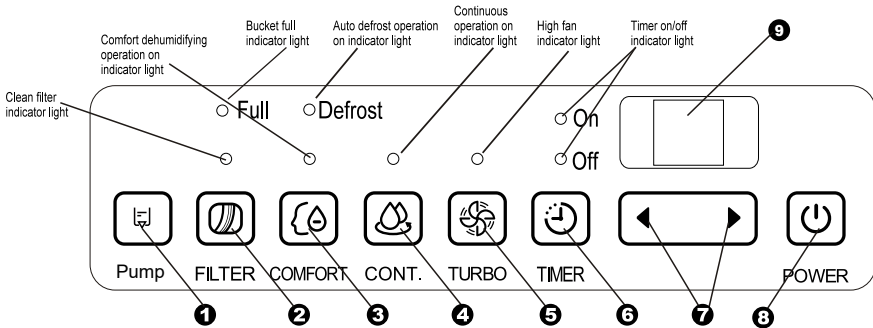

Fig.1

Control pads

When you push the button to change operation modes, the unit will make a beep sound to indicate that it is changing modes.

1 Pump Pad

Press to activate the pump operation.
NOTE: Make sure the pump drain hose is installed into the unit and the continuous drain hose is removed from the unit before the pump operation is activated. When the bucket is full, the pump starts to work. Refer to the next pages for removing the collected water. Do not use this operation when the outdoor temperature is equal to or less than 0°C (32°F).

2 FILTER Pad

The check filter feature is a reminder to clean the Air Filter for more efficient operation. The Filter light (Clean filter light) will illuminate after 250 hours of operation. To reset after cleaning the filter, press the Filter pad and the light will go off.

3 COMFORT Pad (optional)

Press to activate the comfort dehumidifying operation.
NOTE: On this operation, the unit can not be set humidity level.

4 CONTINUE Pad

Press to activate the continuous dehumidifying operation.

5 TURBO Pad

Control the fan speed. Press to select either High or Normal fan speed. Set the fan control to High for maximum moisture removal. When the humidity has been reduced and quiet operation is preferred, set the fan control to Normal.

6 Timer Pad

Press to initiate the Auto start and Auto stop feature, in conjunction with the ◀ and ▶ key pads.

7 ◀ / ▶ : Up/Down Pads

• Humidity Set Control Pads

The humidity level can be set within a range of 35%RH (Relative Humidity) to 85%RH (Relative Humidity) in 5% increments.

For drier air, press the ◀ pad and set to a lower percent value(%).

For damper air, press the ▶ pad and set a higher percent value(%).

• TIMER Set Control Pads

Use the Up/Down pads to set the Auto start and Auto stop time from 0.0 to 24.

8 Power Pad

Press to turn the dehumidifier on and off.

CONTROL PADS ON THE DEHUMIDIFIER

⑨ Display

Shows the set % humidity level from 35% to 85% or auto start/stop time (0~24) while setting, then shows the actual (\pm 5% accuracy) room % humidity level in a range of 30% RH(Relative Humidity) to 90%RH(Relative Humidity).

Error Codes and Protection Code:

AS- Humidity sensor error—Unplug the unit and plug it back in. If error repeats, call for service.

ES- Tube Temperature sensor of the evaporator error— Unplug the unit and plug it back in. If error repeats, call for service.

P2- Bucket is full or bucket is not in right position— Empty the bucket and replace it in the right position.(only available for the unit with no pump feature.)

P2- Bucket is full – Empty the bucket.(only available for the unit with pump feature.)

EC- Refrigerant leakage detection— With this new technology, the display area will appear "EC" when the unit detects refrigerant leakage ,call for service.

E3- Unit malfunction-- Unplug the unit and plug it back in. If error repeats, call for service.

Eb- Bucket is removed or not in right position— Replace the bucket in the right position.(only available for the unit with pump feature.)

Other features

Bucket Full Light

Glowes when the bucket is ready to be emptied.

Auto Shut Off

The dehumidifier shuts off when the bucket is full, or when the bucket is removed or not replaced in the proper position.When the setting humidity is reached, the unit will be shut off automatically. For some models,the fan motor will continue operating.

Auto Defrost

When frost builds up on the evaporator coils, the compressor will cycle off and the fan will continue to run until the frost disappears.

Wait 3 minutes before resuming operation

After the unit has stopped, it can not be restart operation in the first 3 minutes. This is to protect the unit. Operation will automatically start after 3 minutes.

Check filter feature

The system starts to count the time once the fan motor operates. The check filter feature can be only activated when the accumulated operation time achieves 250 hours or more. The Reset light(Clean filter indicator light) flashes at one time per second, after finishing clean the air filter, press the Filter pad and the Reset light(Clean filter indicator light) goes off.

Auto-Restart

If the unit breaks off unexpectedly due to the power cut, it will restart with the previous function setting automatically when the power resumes.

Setting the Timer

- When the unit is on, first press the Timer button, the Timer Off indicator light illuminates. It indicates the Auto Stop program is initiated. Press it again the Time On indicator light illuminates.It indicates the Auto Start is initiated.
- When the unit is off, first press the Timer button, the TIMER ON indicator light illuminates. It indicates the Auto Start program is initiated. Press it again the Time Off indicator light illuminates.It indicates the Auto Stop is initiated.
- Press or hold the UP or DOWN pad to change the Auto time by 0.5 hour increments, up to 10 hours, then at 1 hour increments up to 24 hours. The control will count down the time remaining until start.
- The selected time will register in 5 seconds and the system will automatically revert back to display the previous humidity setting.
- When the Auto start & Auto stop times are set, within the same program sequence, TIMER ON OFF indicator lights illuminate identifying both ON and OFF times are now programmed.
- Turning the unit ON or OFF at any time or adjusting the timer setting to 0.0 will cancel the Auto Start/Stop function.
- When LED display window displays the code of P2, the Auto Start/Stop function will also be cancelled.

IDENTIFICATION OF PARTS

Identification of parts

Front

- ❶ Control panel
- ❷ Panel
- ❸ Water bucket
- ❹ Water level window
- ❺ Handle (both sides)

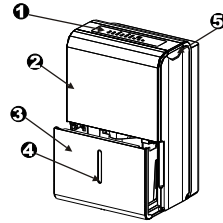

Fig.2

Rear

- ❶ Continuous drain hose outlet
- ❷ Caster
- ❸ Power Cord and plug
- ❹ Power cord buckle (placed in the water bucket, used only when storing the unit. Installed as shown Fig.3a))
- ❺ Pump drain hose outlet(some models without)
- ❻ Air outlet grille
- ❼ Air filter

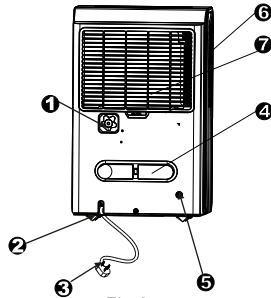
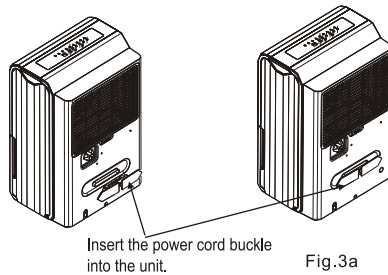

Fig.3

NOTE: All the pictures in the manual are for explanation purposes only. The actual shape of the unit you purchased may be slightly different, but the operations and functions are the same.



Accessories:(placed in the water bucket of the unit)

pump drain hose(1pc)(only for the unit with pump feature)



power cord buckle(1pc)

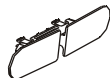

Positioning the unit

A dehumidifier operating in a basement will have little or no effect in drying an adjacent enclosed storage area, such as a closet, unless there is adequate circulation of air in and out of the area.

- Do not use outdoors.
- This dehumidifier is intended for indoor residential applications only. This dehumidifier should not be used for commercial or industrial applications.
- Place the dehumidifier on a smooth, level floor strong enough to support the unit with a full bucket of water.
- Allow at least 20cm of air space on all sides of the unit for good air circulation (at least 40cm of air space on air outlet).
- Place the unit in an area where the temperature will not fall below 5°C(41°F). The coils can become covered with frost at temperatures below 5°C(41°F), which may reduce performance.
- Place the unit away from the clothes dryer, heater or radiator.
- Use the unit to prevent moisture damage anywhere books or valuables are stored.
- Use the dehumidifier in a basement to help prevent moisture damage.
- The dehumidifier must be operated in an enclosed area to be most effective.
- Close all doors, windows and other outside openings to the room.

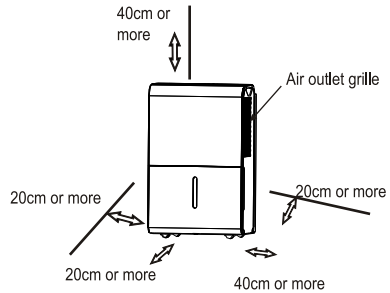

Fig.4a

Casters(At four points on the bottom of unit)

- Casters can move freely.
- Do not force casters to move over carpet, nor move the unit with water in the bucket. (The unit may tip over and spill water.)

When using the unit

- When first using the dehumidifier, operate the unit continuously 24 hours. Make sure the plastic cover on the continuous drain hose outlet install stightly properly so there are no leaks.
- This unit is designed to operate with a working environment between 5°C/41 °F and 35°C/95 °F.
- If the unit has been switched off and needs to be switched on again quickly, allow approximately three minutes for the correct operation to resume.
- Do not connect the dehumidifier to a multiple socket outlet, which is also being used for other electrical appliances.
- Select a suitable location, making sure you have easy access to an electrical outlet.
- Plug the unit into a electrical socket-outlet with earth connection.
- Make sure the Water bucket is correctly fitted otherwise the unit will not operate properly.

NOTE:When the water in the bucket reaches to a certain level,please be careful to move the machine to avoid it falling down.

OPERATING THE UNIT

Removing the collected water

There are three ways to remove collected water.

1. Use the bucket

- When the unit is off, if the bucket is full, the Full indicator light will light.
- When the unit is on, if the bucket is full, the compressor and the fan turn off, and the Full indicator light will light, the digital display shows P2.
- Slowly pull out the bucket. Grip the left and right handles securely, and carefully pull out straight so water does not spill. Do not put the bucket on the floor because the bottom of the bucket is uneven. Otherwise the bucket will fall and cause the water to spill.
- Throw away the water and replace the bucket. The bucket must be in right place and securely seated for the dehumidifier to operate.
- The machine will re-start when the bucket is restored in its correct position.

NOTES:

- When you remove the bucket, do not touch any parts inside of the unit. Doing so may damage the product.
- Be sure to push the bucket gently all the way into the unit. Banging the bucket against anything or failing to push it in securely may cause the unit not to operate.
- If the pump hose drops when you remove the bucket (see Fig.7), you must reinstall the pump hose properly to the unit before replace the bucket into the unit (see Fig.8).
- When you remove the bucket, if there is some water in the unit you must dry it.
- When the unit is on, if the bucket is removed, the compressor and the fan turn off, then the unit will beep 8 times and the digital display shows Eb.
- When the unit is off, if the bucket is removed, the unit will beep 8 times and the digital display shows Eb.

2. Continuous draining

Water can be automatically emptied into a floor drain by attaching the unit with a water hose (Id \geq ϕ 5/16", not included) with a female threaded end (ID:M=1", not included)

- Remove the plastic cover from the back drain outlet of the unit and set aside, then insert the drain hose through the drain outlet of the unit and lead the drain hose to the floor drain or a suitable drainage facility. (See Fig.9 and Fig.10)
- When you remove the plastic cover, if there is some water in the back drain outlet of the unit you must dry it. Make sure the hose is secure so there are no leaks and the end of the hose is level or down to let the water flow smoothly.
- Direct the hose toward the drain, making sure that there are no kinks that will stop the water flowing.
- Select the desired humidity setting and fan speed on the unit for continuous draining to start.

NOTE: When the continuous draining feature is not being used, remove the drain hose from the outlet, and dry the water in the continuous drain hose outlet.

1. Pull out the bucket a little.

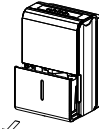

Fig.5

2. Hold both sides of the bucket with even strength, and pull it out from the unit.

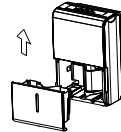

Fig.6

3. Pour the water out.

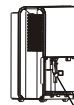

Fig.7 Pump hose drops

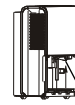

Fig.8 Reinstall pump hose properly

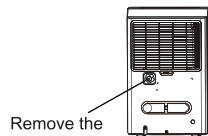

Fig.9

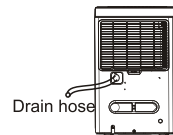

Fig.10

Removing the collected water

3. Pump draining (on some models)

Water can be automatically emptied into a floor drain or a suitable drainage facility by attaching the pump drain out with a pump drain hose (ϕ od=1/4", supplied).

- Remove the continuous drain hose from the unit and install the plastic cover to the continuous drain hose outlet of the unit by clockwise rotation. (See Fig.11)
- Resert the pump drain hose into the pump drain hose outlet for depth of 15mm at least (See Fig.11), then lead the water hose to the floor drain or a suitable drainage facility.
- Press the pump pad of the unit to activated the pump operation. When the bucket is full the pump starts to work.
NOTE: The pump may cause big noise when it starts to work for 3~5 minutes. It is a normal phenomenon.
- Make sure the hose is secure so there are no leaks.
- Direct the hose toward the drain, making sure that there are no kinks that will stop the water flowing.
- Place the end of the hose into the drain and make sure the end of the hose is level or down to let the water flow smoothly. Do never let it up.
- Select the desired humidity setting and fan speed on the unit for pump draining to start.

NOTE: The pump operation on light blinks at 1Hz when the pump is operational failure. Please turn off the unit and plug the power cord out. Check the following things:

- Cleaning the filter of the pump.
 - Remove the bucket from the unit, take down the pump and clean the filter of the pump (See Fig.12).
- Check that the pump drain hose does not link or block.
- Empty the water of the bucket.
- Reinstall the pump hose if it drops and reinstall the bucket properly. Turn on the unit. If the error repeats, call for service.

NOTE: Do not use this operation when the outdoor temperature is equal to or less than 0°C (32°F), otherwise water is become ice that will cause the water hose blocked up and the unit failure. Make sure to empty the bucket once a week when using the pump draining feature. When the pump draining feature is not being used, remove the pump drain hose from the outlet.

- Press the pump drain hose outlet in and take the pump drain hose out from it (See Fig.13). Make sure do not let the water in the pump hose drip to the floor.

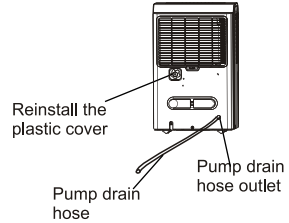
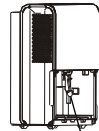

Fig.11



Filter of the pump

Fig.12

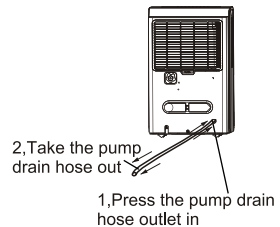

Fig.13

CARE AND MAINTENANCE

Care and cleaning of the dehumidifier

Turn the dehumidifier off and remove the plug from the wall outlet before cleaning.

1. Clean the Grille and Case

- Use water and a mild detergent. Do not use bleach or abrasives.
- Do not splash water directly onto the main unit. Doing so may cause an electrical shock, cause the insulation to deteriorate, or cause the unit to rust.
- The air intake and outlet grilles get soiled easily, so use a vacuum attachment or brush to clean.

2. Clean the bucket

Every few weeks, clean the bucket to prevent growth of mold, mildew and bacteria. Partially fill the bucket with clean water and add a little mild detergent. Swish it around in the bucket, empty and rinse.

NOTE: Do not use a dishwasher to clean the bucket. After clean, the bucket must be in place and securely seated for the dehumidifier to operate.

3. Clean the air filter

- Remove the filter every two weeks based on normal operating conditions.
- To remove the filter, pull filter outwards (See Fig.14).
- Wash the filter with clean water then dry.
- Re-install the filter, replace Bucket.

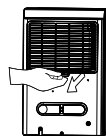

Fig. 14

CAUTION:







DO NOT operate the dehumidifier without a filter because dirt and lint will clog it and reduce performance.

4. When not using the unit for long time periods

- After turning off the unit, wait one day before emptying the bucket.
- Clean the main unit, water bucket and air filter.
- Wrap the cord with the power cord buckle.
- Cover the unit with a plastic bag.
- Store the unit upright in a dry, well-ventilated place.

TROUBLESHOOTING TIPS

Before calling for service, review the chart below first yourself.

Problem		What to check
Unit does not start		<ul style="list-style-type: none">● Make sure the dehumidifier's plug is pushed completely into the outlet.● Check the house fuse/circuit breaker box.● Dehumidifier has reached its preset level or bucket is full.● Water bucket is not in the proper position.
Dehumidifier does not dry the air as it should		<ul style="list-style-type: none">● Did not allow enough time to remove the moisture.● Make sure there are no curtains, blinds or furniture blocking the front or back of the dehumidifier.● The humidity control may not be set low enough.● Check that all doors, windows and other openings are securely closed.● Room temperature is too low, below 5°C(41°F).● There is a kerosene heater or something giving off water vapor in the room.
The unit makes a loud noise when operating		<ul style="list-style-type: none">● The air filter is clogged.● The unit is tilted instead of upright as it should be.● The floor surface is not level.
Frost appears on the coils		<ul style="list-style-type: none">● This is normal. The dehumidifier has Auto defrost feature.
Water on floor		<ul style="list-style-type: none">● Hose to connector or hose connection may be loose.● Intend to use the bucket to collect water, but the back drain plug is removed.
ES, AS,P2,EC ,Eb and E3 appear in the display		<ul style="list-style-type: none">● These are error codes and protection code. See the CONTROL PADS ON THE DEHUMIDIFIER section.
The pump operation on light blinks at 1Hz		<ul style="list-style-type: none">● Clean the filter of the pump.● Check the pump hose does not link or block.● Empty the water of the bucket.