



en

USER MANUAL

Dehumidifier MDP

Rated voltage: 115V
Rated power: 295 ~ 690W
Frequency: 60Hz
Moisture
removal: 30 ~ 70 Pints/day

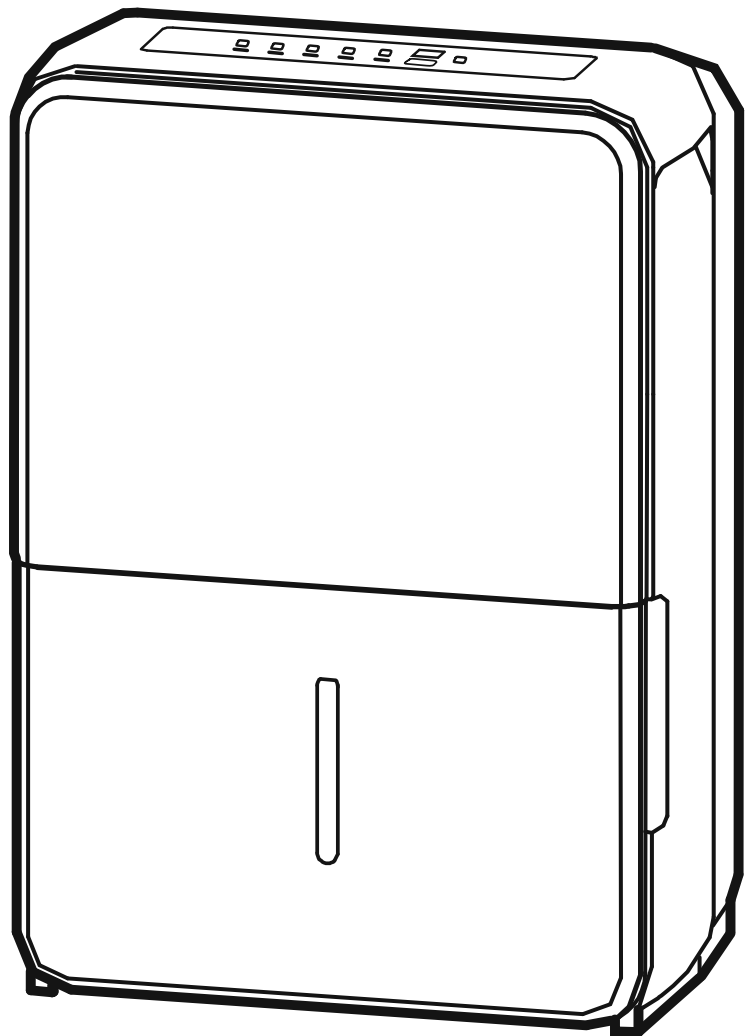

Warning notices: Before using this product, please read this manual carefully and keep it for future reference.

The design and specifications are subject to change without prior notice for product improvement. Consult with your dealer or manufacturer for details.

MDP30SR71
MDP50SR71
MDP70SR71
MDP70PR71
(w/ pump)
www.midea.com

version A - 05 - 2017

0	Safety Precautions	3
1	Unit Specifications and Features	6
2	Operating Instructions	8
3	Installation Instructions	14
4	Care and Cleaning	15
5	Troubleshooting Tips	16

Read This Manual

Inside you will find many helpful hints on how to use and maintain your air conditioner properly. Just a little preventive care on your part can save you a great deal of time and money over the life of your air conditioner. You'll find many answers to common problems in the troubleshooting tips - you should be able to fix most of them quickly before calling service. These instructions may not cover every possible condition of use, so common sense and care for safety is required when installing, operating and maintaining this product.



CAUTION

- Contact the authorized service technician for repair or maintenance of this unit.
- The unit is not designed to be used by young children or people with reduced physical, sensory or mental capabilities without supervision.
- Young children should be supervised to ensure that they do not play with the unit.
- If the power cord needs to be replaced, please contact our consumer service and look for an authorized technician.
- Electrical installation, if needed, must be performed in accordance to national regulation standards by qualified personnel only.

Safety Precautions

To prevent injury to the user or other people and property damage, the instructions shown here must be followed. Incorrect operation due to ignoring of instructions may cause harm or damage. The level of risk is shown by the following indications.



WARNING

This symbol indicates the possibility of death or serious injury.



CAUTION

This symbol indicates the possibility of injury or damage to property.



WARNING

- Plug in power plug properly.
Otherwise, it may cause electric shock or fire due to excess heat generation.
- Do not modify power cord length or share the outlet with other appliances.
It may cause electric shock or fire due to overheat.
- Always ensure effective grounding.
Incorrect grounding may cause electric shock.
- Unplug the unit if strange sounds, smell, or smoke comes from it.
A damaged product may cause fire and electric shock.
- Ventilate room before operating the unit if there is a gas leak from other appliances.
- Do not operate or stop the unit by inserting or pulling out the power plug.
It may cause electric shock.
- Do not allow water to touch into electric parts.
It may cause failure or electric shock.
- Do not use the socket if it is loose or damaged.
It may cause fire and electric shock.
- Do not use or keep the power cord close to heating appliances or heat sources
such as fireplaces.
It may cause fire and electric shock.
- Do not disassemble or modify unit.
It may cause failure and electric shock.
- Do not damage or use an unspecified power cord.
It may cause fire and electric shock.
- If the power cord is damaged, it must be replaced by the manufacturer or an authorized
service center or a similarly qualified person in order to avoid electrical risk.
- Do not use the unit near flammable gas or combustibles, such as gasoline,
benzene, thinner, etc.
It may cause fire.
- Before cleaning, turn off the power and unplug the unit.
- Do not take the water bucket out during operation, the bucket full protection may
be activated and risk electric shock.

 **CAUTION**

- Do not use the unit in small spaces.
Lack of ventilation can cause overheating and fire.
- Do not use in places where water may splash onto the unit.
Water may enter the unit and degrade the insulation. It may cause an electric shock or fire.
- Place the unit on a level, sturdy section of the floor.
If the unit falls over, it may cause water to spill and damage belongings, or cause electrical shock or fire.
- Never insert your finger or other foreign objects into grills or openings. Take special care to warn children of these dangers.
It may cause failure or electric shock.
- Do not climb up on or sit on the unit.
You may be injured if you fall or if the unit falls over.
- Always insert the filters securely, and take caution to avoid injuries to hand and fingers. Clean filter once every two weeks.
- If water enters the unit, turn the unit off and disconnect the power, contact a qualified service technician.
- Do not place flower vases or other water container on top of the unit.
Water may spill inside the unit, causing insulation failure and electrical shock or fire.
- If the unit is knocked over during use, turn off the unit and unplug it from the main power supply immediately. Visually inspect the unit to ensure there is no damage. If you suspect the unit has been damaged, contact a customer service or a qualified technician.
- In a thunderstorm, the power must be cut off to avoid damage to the unit due to lightning.
- Do not run cord under carpeting. Do not cover cord with throw rugs, runners, or similar coverings. Do not route cord under furniture or appliances. Arrange cord away from traffic area and where it will not be tripped over.

 **WARNING - Electrical Information**

- The manufacturer's nameplate is located on the rear panel of the unit and contains electrical and other technical data specific to this unit.
- Be sure the unit is properly grounded. To minimize shock and fire hazards, proper grounding is important. The power cord is equipped with a three-prong grounding plug for protection against shock hazards.
- Your unit must be used in a properly grounded wall receptacle. If the wall receptacle you intend to use is not adequately grounded or protected by a time delay fuse or circuit breaker, have a qualified electrician install the proper receptacle.
- Ensure the receptacle is accessible after the unit installation.
- Do not use extension cords or adapter plugs with this unit. However, if it is necessary to use an extension cord, use an approved "dehumidifier" extension cord only (available at most local hardware stores).
- To avoid the possibility of personal injury, always disconnect the unit from power supply, before installing and/or servicing.

 **WARNING - For your safety**

- Do not store or use gasoline or other flammable vapors and liquids in the vicinity of this or any other appliance.
- Avoid fire hazard or electric shock. Do not use an extension cord or an adapter plug. Do not remove any prong from the power cord.

Unit Specifications and Features



Product overview

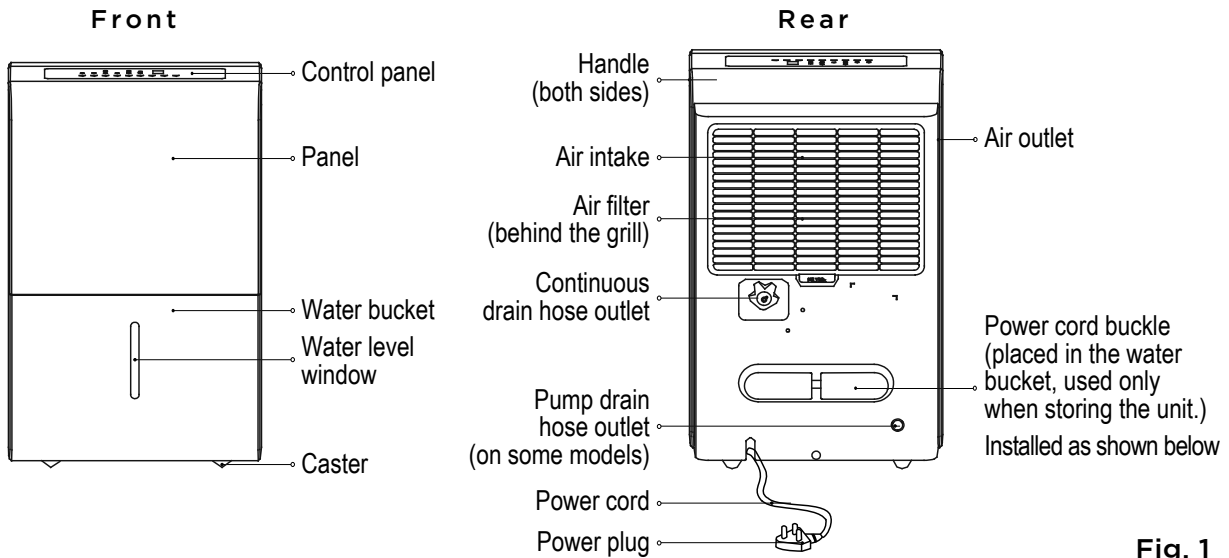
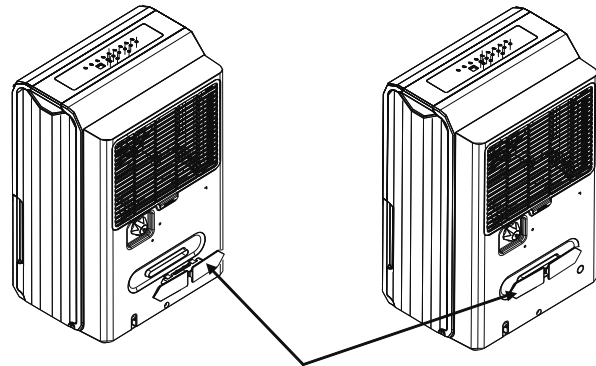

Fig. 1

NOTE

All the pictures in this manual are for illustrative purposes only. The actual shape of the air conditioner you purchased may be slightly different, but its operations and functions are similar.



Insert the power cord buckle into the unit.

Fig. 2

Accessories

Pump drain hose (1 pc) (only for the unit with pump feature)

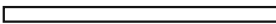

Power cord buckle (1 pc)

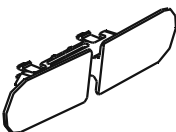

Specifications

MODEL			MDP30SR71	MDP50SR71	MDP70SR71	MDP70PR71 (w/ pump)	
Power supply		Ph-V-Hz	1Ph, 115V-, 60Hz	1Ph-115V-60Hz	1Ph-115V-60Hz	1Ph-115V-60Hz	
Performance	Moisture removal	Pints/day	30	50	70	70	
	Rated input	W	295	495	690	690	
	Rated current	A	2.8	4.7	6.5	6.5	
	Energy factor	L/kWh	2.0	2.0	2.0	2.0	
Starting current		A	14	24	29	29	
System	Refrigerant type	ozs	R-410A	R-410A	R-410A	R-410A	
	Design pressure	PSIG	540/300	540/300	540/300	540/300	
	Water tank volume	L	3	6	6	6	
	Air flow (Hi/Med/Lo)	m ³ /h		234/219	320/280	320/280	320/280
		CFM (ft ³ /min)		138/129	188/165	188/165	188/165
Noise level (Hi/Med/Lo)	dB(A)		54.3	48	53.5	53.5	
Control type			Electronic Control	Electronic Control	Electronic Control	Electronic Control	
Application	Set RH Range		35%-85%RH	35%-85%RH	35%-85%RH	35%-85%RH	
	Ambient temperature	°C	5 - 35	5 - 35	5 - 35	5 - 35	
		°F	41 - 95	41 - 95	41 - 95	41 - 95	
Dimension (W*D*H)		mm	386x260x500	392x282x616	392x282x616	392x282x616	
		in	15.2x10.2x19.7	15.4x11x24.3	15.4x11x24.3	15.4x11x24.3	
Net/Gross weight		kg	14.5/16	15.5/16.5	18/19.3	19/20.3	
		lb	32.0/35.3	34.2/36.4	39.7/42.5	41.9/44.8	

Operating Instructions

2

CAUTION

Clean your unit occasionally to keep it looking new. Be sure to unplug the unit before cleaning to prevent chock or fire hazards.

Key Pad Features

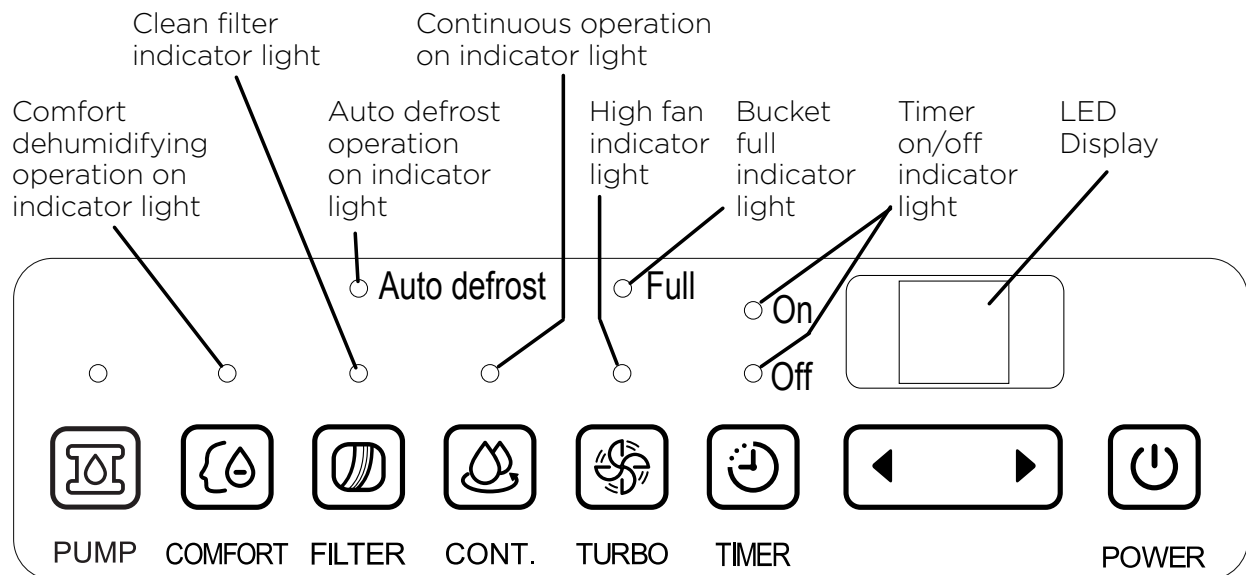

NOTE

The control panel of the unit you purchased may be slightly different according to the models.

Control Pads

When you push the button to change operation modes, the unit will make a beep sound to indicate that it is changing modes.

(COMFORT) Button

Press to activate the comfort dehumidifying operation.

NOTE

When COMFORT function is turned on, set humidity is automatic and cannot be changed manually.

(FILTER) Button

This feature is a reminder to clean the Air Filter for more efficient operation. The LED (light) will illuminate after 250 hours of operation. To reset after cleaning the filter, press the Filter button and the light will go off.

(CONTINUE) Button

Press to activate the continuous dehumidifying operation.

(TURBO) Button

Control the Turbo speed. Press to select either Turbo or normal fan speed. Set the Turbo control to high for maximum moisture removal. When room humidity is at your preferred level, it is advised to turn off Turbo speed.

(TIMER) Button

Starts the Timer ON and Timer OFF function setting.

Up/Down Buttons (◀ / ▶)

- **Humidity Set Control Buttons**

The humidity level can be set within a range of 35% RH (Relative Humidity) to 85% RH (Relative Humidity) in 5% increments.

For drier air, press the ◀ button and set to a lower value (%).

For damper air, press the ▶ button and set a higher value (%).

- **TIMER Set Control Buttons**

Use the ◀ and ▶ key buttons to set the Timer ON or Timer OFF from 0 to 24 hours.

(POWER) Button

Press to turn the dehumidifier on and off.

LED Display

Shows the set % humidity level from 35% to 85% or auto start/stop time (0 ~ 24) while setting, then shows the actual (+/- 5% accuracy) room % humidity level in a range of 30% RH (Relative Humidity) to 90% RH (Relative Humidity).

Error Codes and Protection Code:

AS - Humidity sensor error - Unplug the unit and plug it back in. If error persists, contact Customer Service.

ES - Tube Temperature sensor of the evaporator error - Unplug the unit and plug it back in. If error persists, contact Customer Service.

P2 - Bucket is full or bucket is not in right position - Empty the bucket and replace it in the right position. (only available for the unit with no pump feature.)

P2 - Bucket is full - Empty the bucket. (only available for the unit with pump feature.)

EC - Refrigerant leakage detection - Display area will show EC when the unit detects refrigerant leakage. If error persists, contact Customer Service.

E3 - Unit malfunction - Unplug the unit and plug it back in. If error persists, contact Customer Service.

Eb - Bucket is removed or not in right position - Replace the bucket in the right position. (only available for the unit with pump feature.)

Other Features**Bucket Full Light**

Lights up when the bucket is ready to be emptied.

Auto Shut Off

The dehumidifier shuts off when the bucket is full, or when the bucket is removed or not replaced in the proper position. When the setting humidity is reached, the unit will be shut off automatically. The fan motor will continue operating.

Auto Defrost

When frost builds up on the evaporator coils, the compressor will cycle off and Auto Defrost function will run automatically.

Other Features (cont.)

Wait 3 minutes before resuming operation

After the unit has stopped, it can not be restarted in the first 3 minutes to protect compressor operation. The unit will restart automatically after 3 minutes.

Auto-Restart

If the unit stops unexpectedly due to a power cut, it will restart with the previous function setting automatically when the power resumes.

Setting the Timer ON and Timer OFF

- When the unit is on, first press the Timer button, the Timer OFF indicator light illuminates. It indicates the Timer OFF program is initiated. Press it again the Timer ON indicator light illuminates. It indicates the Timer ON is initiated.
- When the unit is off, first press the Timer button, the Timer ON indicator light illuminates. It indicates the Timer ON program is initiated. Press it again the Timer OFF indicator light illuminates. It indicates the Timer OFF is initiated.
- Press or hold the ◀ and ▶ key buttons to change the Timer by 0.5 hour increments, up to 10 hours, then at 1 hour increments up to 24 hours. The control will count down the time remaining until start.
- The selected time will register in 5 seconds and the system will automatically revert back to display the previous humidity setting.
- When the Timer ON and Timer OFF times are set, within the same program sequence, indicator lights illuminate identifying both ON and OFF times are now programmed.
- Turning the unit ON or OFF at any time or adjusting the timer setting to 0.0 will cancel the Timer function.
- When LED display window displays the code of P2, the Auto Start/Stop function will also be cancelled.

NOTES

- When first using the dehumidifier, operate the unit continuously 24 hours. Make sure the plastic cover on the continuous drain hose outlet install stightly properly so there are no leaks.
- This unit is designed to operate with a working environment between 5°C/41°F and 35°C/95°F.
- Make sure the water bucket is positioned correctly so that the unit can operate properly. When the water in the bucket reaches to a certain level, please be careful to move the unit to avoid it spill.

Removing Collected Water

There are three ways to remove collected water:

1. Use the bucket

- When the unit is off, if the bucket is full, the Full indicator light will light.
- When the unit is on, if the bucket is full, the compressor and the fan turn off, and the Full indicator light will light, the digital display shows P2.
- Slowly pull out the bucket. Grip the left and right handles securely, and carefully pull out straight so water does not spill. Do not put the bucket on the floor as because the bottom of the bucket is uneven. Otherwise water may be spilled.
- Throw away the water and reposition the bucket.
- The unit will restart operation when the bucket back in place.

NOTES

- When you remove the bucket, do not touch any parts inside the unit. Doing so may damage the product.
- Be sure to push the bucket gently all the way into the unit.
- If the pump hose drops when you remove the bucket (see Fig. 7), you must reinstall the pump hose properly to the unit before replacing the bucket into the unit (see Fig. 8).
- When the unit is on, if the bucket is removed, the compressor and the fan turn off, then the unit will beep 8 times and the digital display shows Eb.
- When the unit is off, if the bucket is removed, the unit will beep 8 times and the digital display shows Eb.

1. Pull out the bucket.

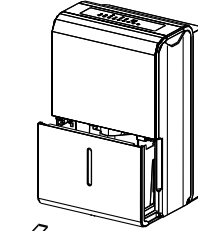

2. Hold both sides of the bucket evenly, and pull it out from the unit.

Fig. 5

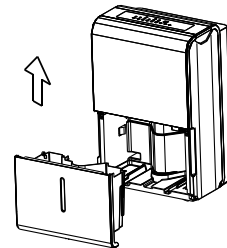

3. Pour the water out.

Fig. 6

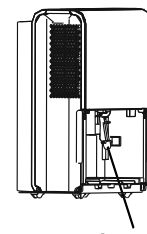

Pump hose drops

Fig. 7

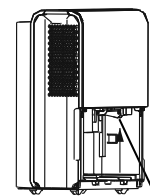

Reinstall pump hose properly

Fig. 8

2. Continuous draining

- Water can be automatically emptied into a floor drain by attaching the unit with a water hose (Id $\geq \varnothing 5/16"$, not included) with a female threaded end (ID: M = 1", not included).
- Remove the plastic cover from the back drain outlet of the unit and set aside, then insert the drain hose through the drain outlet of the unit and lead the drain hose to the floor drain or a suitable drainage facility. (See Fig. 9 and Fig. 10)
- When you remove the plastic cover, if there is some water in the back drain outlet of the unit you must dry it. Make sure the hose is secure so there are no leaks and the end of the hose is level or down to let the water flow.
- Direct the hose toward the drain, making sure that there are no kinks that will stop the water flowing.
- Select the desired humidity setting and fan speed on the unit for continuous draining to start.

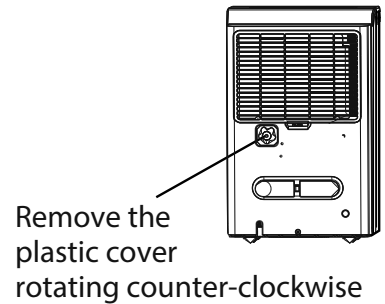

Fig. 9

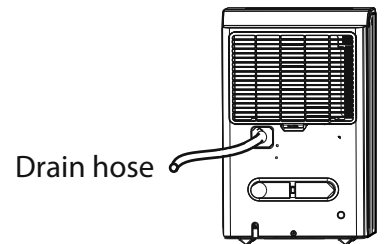

Fig. 10

NOTE

When the continuous draining feature is not being used, remove the drain hose from the outlet, and dry the water in the continuous drain hose outlet.

Removing the Collected Water (cont.)

3. Pump draining (Pump models only)

Water can be automatically emptied into a floor drain or a suitable drainage facility by attaching the pump drain out with a pump drain hose (\varnothing od = 1/4", supplied).

- Remove the continuous drain hose from the unit and install the plastic cover to the continuous drain hose outlet of the unit by clockwise rotation. (See Fig. 11)
- Insert the pump drain hose into the pump drain hose outlet for at least 15mm (See Fig. 11), then lead the water hose to the floor drain or a suitable drainage facility.
- Press the pump pad on the unit to activate the pump operation. When the bucket is full the pump starts to work.

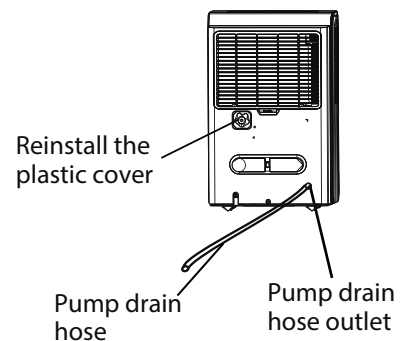

Fig. 11

NOTE

The pump may generate a loud noise when it starts to work for 3 ~ 5 minutes.

- Make sure the hose is secure so there are no leaks.
- Direct the hose toward the drain, making sure that there are no kinks that will stop the water flowing.
- Place the end of the hose into the drain.
- Select the desired humidity setting and fan speed on the unit for pump draining to start.

NOTE

The pump operation light blinks when a failure occurs. Please turn off the unit and disconnect the power cord. Check the following things:

- Cleaning the pump filter:
 - Remove the bucket from the unit, take down the pump and clean the pump filter (See Fig. 12).
- Check if the drain hose is clean and free of debris.
- Empty the water of the bucket.
- Check the hose connection and the bucket for proper fitting. If the error persists, contact Customer Service.

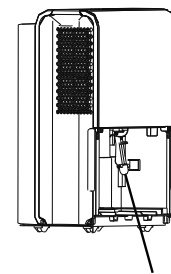

Filter of the pump

Fig. 12

NOTE

Do not use this operation when the outdoor temperature is equal to or less than 0°C (32°F), otherwise water may become ice causing the water hose to be blocked and the unit to stop operating.

Make sure to empty the bucket at least once a week a week when using the pump draining feature. When the pump draining feature is not being used, remove the pump drain hose from the outlet.

Installation Instructions

3

Positioning the Unit

A dehumidifier operating in a basement will have little or no effect in drying an adjacent enclosed storage area, such as a closet, unless there is adequate circulation of air in and out of the area. (See Fig. 13)

- Do not use outdoors.
- This dehumidifier is intended for indoor residential applications only. This dehumidifier should not be used for commercial or industrial applications.
- Place the dehumidifier on a smooth, level floor strong enough to support the unit with a full bucket of water.
- Allow at least 8 inches of air space on all sides of the unit for air circulation (at least 16 inches for air outlet).
- Place the unit in an area where the temperature will not fall below 41°F (5°C). The coils can become covered with frost at at lower temperatures, which may reduce performance.
- Place the unit away from any clothes dryer, heater or radiator.
- Close all doors, windows and other outside openings to the room.

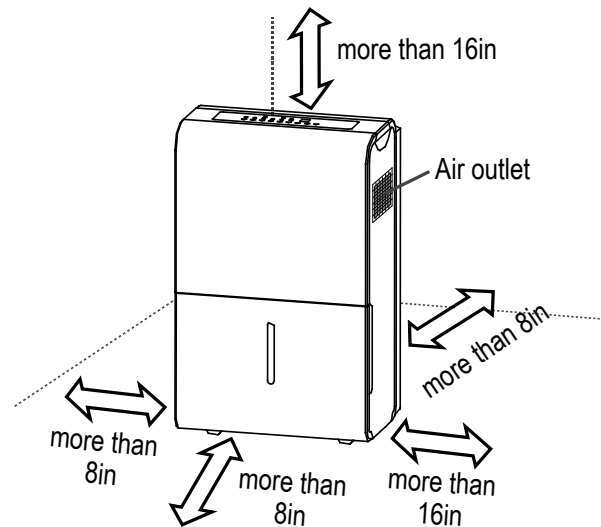

Fig. 13

Care and Cleaning

4

Turn the dehumidifier off and disconnect the plug from the wall before cleaning.

1. Clean the Grill and Case

- Use water and a mild detergent. Do not use bleach or abrasives.
- Do not splash water directly onto the unit. Doing so may cause an electrical shock, cause the insulation to deteriorate, or cause the unit to rust.
- The air intake and outlet may get dirty during operation, use a vacuum cleaner or brush to clean.

2. Clean the bucket

Every few weeks, clean the bucket thoroughly to prevent growth of mold, mildew and bacteria. Partially fill the bucket with clean water and mild detergent. Swish it around in the bucket, empty and rinse.

NOTE

Do not use a dishwasher to clean the bucket.

3. Clean the air filter

- To remove the filter, pull filter outwards (See Fig. 14).
- Wash the filter with clean water then dry.
- Re-install the filter, replace bucket.

! CAUTION

DO NOT operate the dehumidifier without a filter to avoid loss of performance and damage to the unit.

4. When not using the unit for long time periods

- Before storing the unit, let it rest for one full day so that the system can dry out naturally.
- Clean the unit, water bucket and air filter.
- Wrap the cord with the power cord buckle.
- Cover the unit with a plastic bag.
- Store the unit upright in a dry, well-ventilated place.

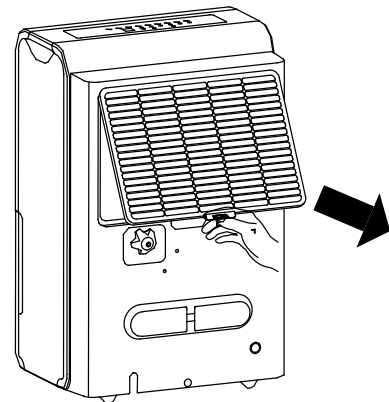

Fig. 14

Troubleshooting Tips

5

Before calling for service, review this list. It may save you time and money. This list includes common occurrences that are not the result of defective workmanship or materials in this appliance.

Problem	Solution
Unit does not start	Make sure the dehumidifiers plug is connected firmly into the wall outlet.
	Check the house fuse/circuit breaker box.
	Dehumidifier has reached its preset level or bucket is full.
	Water bucket is not in the proper position.
Dehumidifier does not dry the air as it should	Not enough time to remove the moisture.
	Make sure there are no curtains, blinds or furniture blocking the front or back of the dehumidifier.
	The humidity control may not be set low enough.
	Check that all doors, windows and other openings are securely closed.
	Room temperature is too low, below 5°C(41°F).
	There is a water vapor source in the room.
The unit makes a loud noise when operating	Air filter may be dirty. Clean filter. Refer to Care and Cleaning section.
	The unit is tilted instead of upright as it should be.
	The floor surface is not level.
Frost appears on the coils	This is normal. The dehumidifier has Auto defrost feature.
Water on floor	Hose to connector or hose connection may be loose.
	Intend to use the bucket to collect water, but the back drain plug is removed.
ES, AS, P2, EC, Eb and E3 appear in the display	These are error codes and protection code. Check Operating Instructions.
The pump operation on light blinks at 1 Hz	Clean the pump filter.
	Check the pump hose is not blocked or leaking.
	Empty the water bucket.

