







Shinco[®]

Manual of dehumidifier

Model No. SDO-40P



CONTENTS

	Placement guidelines.....	2
	Important Safety Instructions.....	4
	Operation.....	7
	Care &Cleaning.....	10
	Troubleshooting	11
	Warranty.....	12

Before First Use:

To prevent any internal damage, it is very important to keep refrigeration units (like this one) upright throughout their journey. Please leave it standing upright and outside the box for **24 HOURS** before plugging it in.

For Customers:

Thank you for purchasing our dehumidifier.

We wish that our products and services can bring convenience to your work and life. We highly recommend that you keep the manual for reference if you encounter unexpected events using the unit. Please read the manual carefully to ensure the proper use of the dehumidifier. The dehumidifier from operating quickly and efficiently to reduce room's humidity and bring you a healthy and comfortable life.



Placement guidelines

The dehumidifier should be used in closed rooms for efficient work. When operating the appliance, keep doors, windows and other openings closed. Make sure to maintain distances of 15.8 in (40cm) upwards and 19.7 in (50cm) sideways for free air circulation. The dehumidifier has the function of drying clothes. Make sure to maintain distances of ≥ 19.7 in (50cm) on all sides to the wet laundry.

Do not operate the dehumidifier near dryers, heaters or radiators.

As shown below:

This dehumidifier is designed to operate with a working environment between 41°F (5°C) and 90°F (32°C).

Casters (Installed at four points on the bottom of the dehumidifier)

- Do not force casters to move over carpet, or move the dehumidifier with water in the bucket. (The dehumidifier may tip over and spill water.)

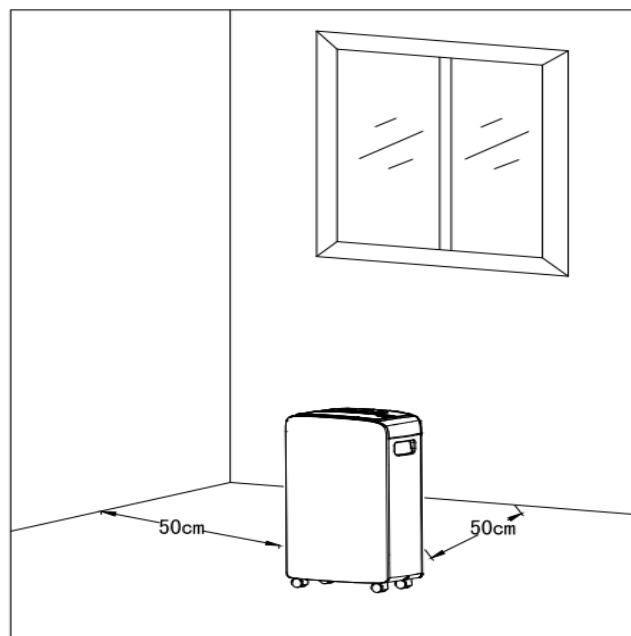

Important Safety Instructions

SAVE THESE INSTRUCTIONS

To prevent injury to the user or other people and property damage, the following instructions must be followed when using the dehumidifier. Incorrect operation due to ignoring of instructions may cause harm or damage.

1. Before using, please gently open the air outlet's swing door.
2. Place the machine in a flat place to reduce vibration and noise.
3. Don't place the machine into water or other liquids.
4. To prevent accidents, please do not use this machine when the wires or other connections are damaged.
5. Please unplug the power when you stop using, reset or clean the machine.
6. Please use it under the specified voltage.
7. This machine can only be used indoor.
8. Don't put heavy objects on the machine.
9. Please empty the water tank before restarting the machine to avoid spills.
10. Don't tilt the machine to avoid damage to the machine by spilled water.
11. Do not use the dehumidifier near flammable gas or combustibles, such as gasoline, benzene, thinner, etc.
12. Never insert your finger or other foreign objects into grills or openings. Take special care to warn children of these dangers.
13. Care should be taken when using the dehumidifier in a room with the following persons: infants, children, the elderly and people not sensitive to humidity.
14. If the power cord is damaged, in order to avoid danger, it must be replaced by professionals.
15. Do not drink or use the water drained from the dehumidifier.

ELECTRICAL INFORMATION

- Be sure the dehumidifier is properly grounded. To minimize shock and fire hazards, proper grounding is important. This power cord is equipped with a three-prong grounding plug for protection against shock hazards.
- Your dehumidifier must be used in a properly grounded wall socket. If your wall socket is not adequately grounded or protected by a time delay fuse or circuit breaker, have a qualified electrician install the proper socket.
- Avoid fire hazard or electric shock. Do not use an extension cord or an adapter plug.

Do not remove any prong from the power cord.

Product overview

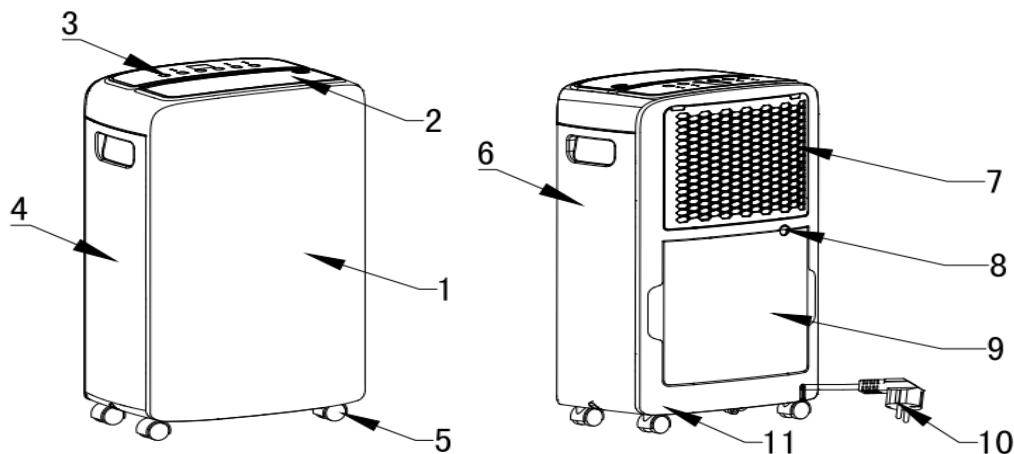

1. Front panel 2. Air outlet grille 3. Control panel 4. Left side panel
5. Caster 6. Right side panel 7. Air intake grille/Air filter 8. Drain hose outlet
9. Water tank 10. Power cord 11. Back panel

Technical Parameters			
Model		Unit	SDO-40P
Dehumidifying capacity		Pint/Day	90°F,RH90%
			40
Power Supply		V~,Hz	110-120, 60Hz
Rated input		W	370W
Rated Current		A	3.3
Refrigerant			R410A
Air Flow		m³/h	180
Water Tank Capacity		L	2.0
Noise	High	dB(A)	48
Body Size	W×H×D	mm	190×292×501
Package Size	W×H×D	mm	246×341×525
Net Weight/Gross Weight		kg	10/12
Application Area		m²	15~18
Power Cord Length		m	1.8
24-hour Timing Function			√
Display mode			LED
Appearance color			White

Operation



Switch On/Off button

Press ON/OFF button.

The current humidity level in the room shows in the display screen.

(Notes: When the machine is powered on for the first time, the machine uses automatic dehumidification mode by default and operates in low wind.)



Mode button

Press MODE to switch between automatic (when it reaches the humidity you set, it will stop) and continuous (it will always dehumidify without stopping) dehumidification.

(Notes: After selecting the mode, next time you turn on the machine, it will run the last operating mode.)



Setting humidity level button

Ensure that the appliance is in Auto mode. Press UP or DOWN to set the desired humidity level. The appliance will start to work until the desired level is reached.

(Notes: The default relative humidity of the machine is 50%.)



Fan speed button

Press WIND to switch between highly efficient (hi-efficient) and silent (Silence) fan speed.

(Notes: Only work in auto mode. And you can press it for 5s to start the inside drying function of this machine.)



Timer button

To run the dehumidifier for a preset amount of hours, press TIMER. "0" blinks on the display. Set the time you wish the appliance to operate between 1 and 24 hours.

(Notes: If you want to change the time you just set, press the timer button again to reset it. And you can set time to turn on this machine by pressing this button in standby.)



Empty the container

If "Water full" lights up and the display shows "FL", the water tank needs to be emptied (see "Empty the water tank") , After reinstalling the emptied water tank, the dehumidifier restarts automatically after three mins.

REMOVING THE COLLECTED WATER

There are two ways to remove collected water:

1. Use the bucket

When the bucket is full, remove the bucket and empty it. Please take out the water tank with both hands to avoid spilling water. Then reinstall it properly.

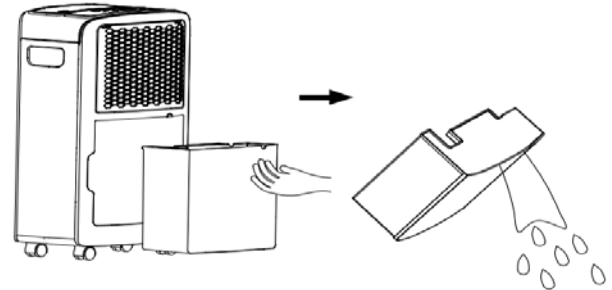

2. Continuous draining

Water can be automatically be emptied into a floor drain by attaching the dehumidifier to a water hose.

STEP 1: Cut off the power;

STEP 2: Remove the 3 plastic seals by needle-nose pliers at the continuous drainage outlet behind the machine.

STEP 3: Connect the water pipe (Inner diameter * wall thickness = 9mm * 2mm) to the drainage outlet.

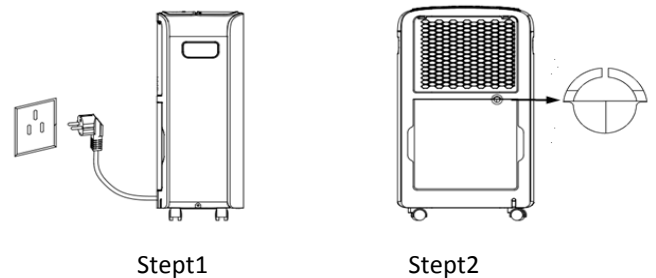

STEP 4: After placing the water tank, the continuous drainage function can be used.

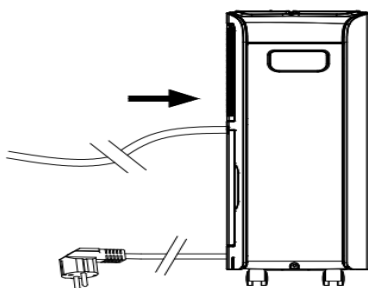

(Notes: Please place it higher, the water pipe shall not be bent and the other end of the water pipe shall not be higher than the drainage outlet.)

Care & Cleaning

⚠ WARNING: Turn the dehumidifier off and remove the plug from the wall outlet before cleaning.

1. Clean the bucket

Clean the bucket every two weeks with a mild cleaning detergent and water.

2. Clean the air filter

Clean the filter with potable water at least once every 30 days.

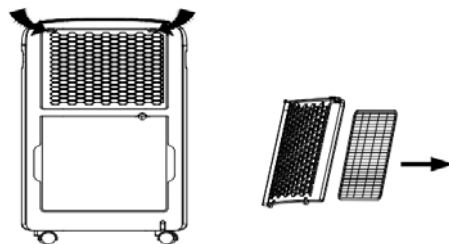

The steps to remove the filter are as follows:

Step 1: Remove the filter frame through the position indicated by the arrows on both sides of the filter frame;

Step 2: Remove the filter by pressing the buckle on the side of the filter. Wash the filter in clean water with a soft brush.

(Notes: It must be air-dried naturally after cleaning. Never use any type of dryer.)

3. Storing the dehumidifier

When not using the dehumidifier for long time periods:

- Press "WIND" button for 5s to start the inside drying function of this machine, the process will take about 45min-1h;
- Clean the main dehumidifier, bucket and air filter.
- Wrap the cord and bundle it with the band.
- Cover the dehumidifier with a soft cloth.
- Store the dehumidifier upright in a dry, well-ventilated place.

Troubleshooting

(Before contact our customer service, review this list. It may save your time and expense. This list includes the most common occurrences that are not the result of defective workmanship or materials in this dehumidifier.)

Problem	Cause&Solution
Dehumidifier does not run	Make sure the dehumidifier's plug is inserted completely into the outlet.
	Bucket is not in the proper position, reinstall the bucket gently.
	Adjust the set humidity of the machine to be lower than the ambient humidity.
	It is recommended to use this machine at an ambient temperature of 5-35°C.
Dehumidifier does not dry the air as it should	Did not work enough time to remove the moisture.
	Make sure there are no curtains, blinds or furniture blocking the front or back of the dehumidifier.
	The humidity selector may not be set low enough.
	Check that all doors, windows and other openings are securely closed.
	Room temperature is too low, below 41°F (5°C).
There is not a kerosene heater or something giving off water vapor in the room.	
Frost appears on the coils	This is normal. The dehumidifier has Auto defrost feature.
Water leaking	Hose to connector or hose connection may be loose.
Noise	The dehumidifier stands tilted and not upright. The floor is not flat.
	Filter is blocked, pls clean the filter.
Water does not drain from the hose	It is recommended to keep the hose as short as possible for proper draining. The hose must be placed lower than the bottom of the dehumidifier, and be kept flat and smooth without kinks.

Error code	Meaning	Solution
E2	Temperature sensor is defective	Unplug the plug and wait a while before plugging it in. If the error still occurs, pls contact us.
P1	The unit is in the defrosting state	It will disappear automatically when the unit has defrosted
Fl	Water tank is full or not inserted correctly	Empty the water tank and insert it correctly into the unit.

(Please contact our Customer Service by writing an email to: service@shinco.net. if dehumidifier operates abnormally or does not operate, and the solutions above are not useful.)

Warranty

TO OBTAIN WARRANTY SERVICE:

Please contact us by email.

Sales support: **service@shinco.net**

WARRANTY PERIOD :

Labor: 1 Year from the Date of Purchase.

Parts: 1 Year from the Date of Purchase.

SHINCO Electric Co., Ltd reserves rights to upgrade products without user notice.