

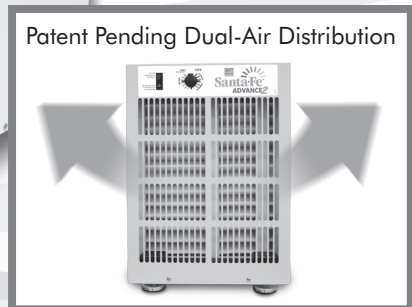

Santa Fe™ ADVANCE2

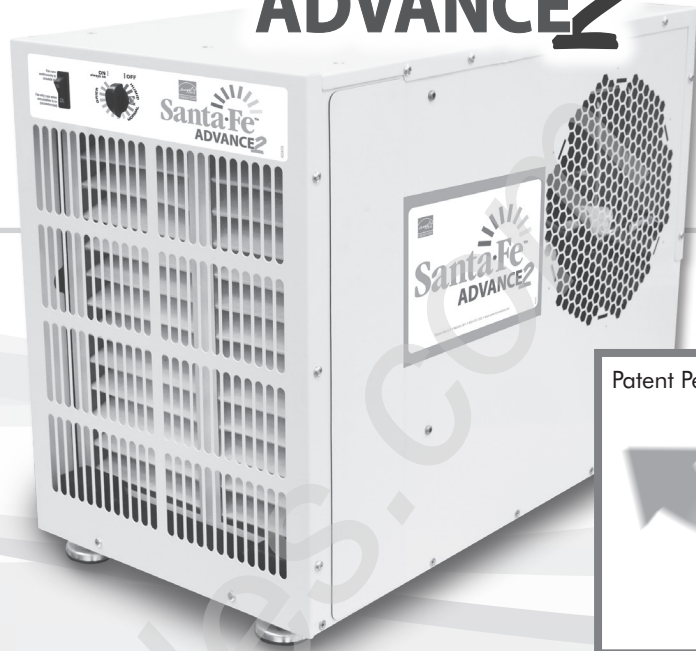

Installation & Operation Instructions

The **Santa Fe Advance2** has a horizontal configuration and unique dual airflow outlets that make it an ideal solution for basements and crawl spaces. Installation flexibility makes the unit ideal for almost any application. No conventional dehumidifier can perform as efficiently and effectively in basements and crawl spaces as the Santa Fe Advance2.

P/N: 4034180 Serial No.: _____ Install Date: _____

Sold by: _____

www.Santa-Fe-Products.com ■ 1.800.533.7533

Table of Contents

Safety Instructions	3
Intended Applications	3
Registrations.....	3
Specifications	4
Dehumidifier Set Up	5
Items Included In Box.....	5
Important Precautions	5
Location Considerations.....	5
Installing Leveling Feet.....	5
Ducting to Finished Areas (Optional)	6
Attaching Duct Collars	6
Recommended Installations.....	7
Drain Installation	8
Operation	9
Humidity Control Adjustment.....	9
Defrost Cycle.....	9
Fan Operation	9
Air Filtration	10
Changing The Filter	10
MERV Rating Chart	11
Electrical Requirements	12
Service	13
Replacement Parts	13
Refrigerant Charging	13
Compressor / Capacitor Replacement	13
Troubleshooting	13
Warranty	15



4201 Lien Rd. Madison, WI 53704

1-800-533-7533

www.Thermastor.com | www.Santa-Fe-Products.com

© 2016 Therma-Stor LLC

Safety Instructions

READ THE INSTALLATION, OPERATION AND MAINTENANCE INSTRUCTIONS CAREFULLY BEFORE INSTALLING AND OPERATING THIS DEVICE. PROPER ADHERENCE TO THESE INSTRUCTIONS IS ESSENTIAL TO OBTAIN MAXIMUM BENEFIT FROM YOUR SANTA FE DEHUMIDIFIER.

WARNING!

THIS SYMBOL MEANS IMPORTANT INSTRUCTIONS. FAILURE TO HEED THEM CAN RESULT IN SERIOUS INJURY OR DEATH.

CAUTION!

THIS SYMBOL MEANS IMPORTANT INSTRUCTIONS. FAILURE TO HEED THEM CAN RESULT IN INJURY OR MATERIAL PROPERTY DAMAGE.

- Never operate a unit with a damaged power cord. If the power cord is damaged, it must be replaced by the manufacturer, its service agent, or a similarly qualified person in order to avoid a hazard.
- Do not unplug the unit by pulling on the cord. Grasp the plug firmly and pull it out of the wall socket or power receptacle.
- When plugging in the unit, use a Ground Fault Interrupter outlet.
- This appliance is not intended for use by persons (including children) with reduced physical, sensory or mental capabilities, or lack of experience or knowledge, unless they have been given supervision or instruction concerning the use of the appliance by a person responsible for their safety. Children should be supervised to ensure that they do not play with the appliance.
- Never operate electrical equipment near or in standing water.
- Do not stick your fingers or other objects through the safety grill.
- The unit must be used in the upright position.
- When changing filters, do not stick fingers or other objects in the unit.
- Do not restrict airflow in to or out of the unit. This may cause the unit to overheat.
- The unit should never be serviced or cleaned while it is plugged in.
- Do not sit or stand on the unit, or use as a shelf or table.
- Before leaving the unit unattended, ensure children do not have access to the equipment. Do not allow children to play with or near the unit or in its air flow.
- The unit is designed to be installed indoors only.
- No user serviceable components. Contact installer or call 1-800-533-7533 for all repair or warranty needs.

Intended Application(s)

The Santa Fe Advance2 is intended for use in crawlspaces or basements: however, the unit can be placed in almost any residential setting where dehumidification is desired. Use in non-residential applications and pool areas may void warranty.

The Santa Fe Advance2 is designed to operate in temperatures between 49° and 95°F. This unit works most effectively between 56° and 95°.

In order to efficiently control humidity levels, the area in which the dehumidifier is to be operated must be free of water intrusion or excessive fresh (outside) air infiltration. Before installing the Santa Fe Advance2, water intrusion and air infiltration problems should be addressed.

Registrations



The Santa Fe Advance2 conforms to unified standard UL 60335-2-40 and CSA standard C22.2.60335-2-40.

Specifications

Part Number:	4034180
Blower:	309 CFM @ 0.0" WG
Power:	640 watts @ 80°F and 60% RH
Supply Voltage:	115 volt – 1 phase – 60 Hz
Current Draw:	5.7 amps
Operating Temp.:	49°F Min., 95°F Max.

Sized For: (Refer to website for more sizing considerations)

Crawl Space

Very Tightly Sealed	Up to 3,400 Sq. Ft. (17,000 Cu. Ft.)
Moderately Sealed	Up to 2,600 Sq. Ft. (13,000 Cu. Ft.)
Some Leaks & Imperfections	Up to 2,200 Sq. Ft. (11,000 Cu. Ft.)

Basement

Very Tightly Sealed	Up to 2,700 Sq. Ft. (27,000 Cu. Ft.)
Moderately Sealed	Up to 2,400 Sq. Ft. (24,000 Cu. Ft.)
Some Leaks & Imperfections	Up to 2,200 Sq. Ft. (22,000 Cu. Ft.)

Minimum Performance at:

	80°F and 60%RH	70°F and 60%RH
Water Removal:	90 Pints/Day	71 Pints/Day
Efficiency:	6.1 Pints/kWh	4.9 Pints/kWh
Energy Factor:	2.88 L/kWh	2.3 L/kWh

Air Filter:	MERV-8, Standard Pleat
Size:	14" x 17.5" x 2"

Power Cord:	9', 115 VAC, Ground
--------------------	---------------------

Drain Connection:	3/4" Threaded Female NPT
--------------------------	--------------------------

Drain Hose:	8' Direct Gravity Drain Hose (5/8" ID x 7/8" OD)
--------------------	--

Refrigerant Type:	R410A (Refer to manufacturers label for more information)
--------------------------	---

Refrigerant Amount:	1 lb., 5 oz.
----------------------------	--------------

Dimensions:	Unit	Shipping
Width:	14.5"	23"
Height:	19.4"	30"
Length:	26"	40"
Weight:	80 lbs	95 lbs

Optional Accessories:

- 4031062 MERV-8 Filter (1.75" x 14" x 17.5")
- 4033036 MERV-8 Filters 4-Pack
- 4033037 MERV-8 Filters 12-Pack
- 4035319 MERV-11 Filter (1.75" x 14" x 17.5")
- 4035131 MERV-11 Filters 4-Pack
- 4035132 MERV-11 Filters 12-Pack
- 4033038 Pump Kit
- 4028616 Caster Kit
- 4036695 Hang Kit
- 4033039 Duct Kit, Supply Only
- 4035646 Duct Kit, Return Only
- 4026969 10" Flex Duct 25'
- 4022126 10" Flex Insulated Duct 25'
- 4020175 Remote Dehumidistat

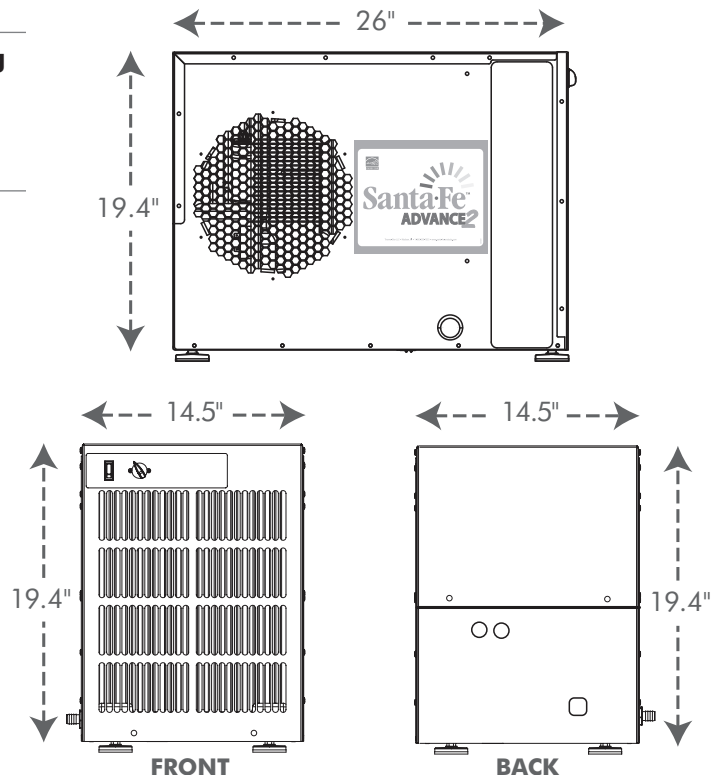

Dehumidifier Set Up



⚠ CAUTION! REMOVE COMPRESSOR SHIPPING TIE FROM THE UNIT. FAILURE TO REMOVE SHIPPING TIE WILL CAUSE EXCESS VIBRATION TO BE TRANSMITTED TO THE FRAME.

The Santa Fe Advance2 uses a compressor to power the refrigeration system. To protect the compressor and refrigeration system during shipping a plastic tie wrap secures it to the units frame. Remove the tie wrap by cutting the tie wrap and pulling from the unit as shown. After removing tie wrap, insert plastic plugs provided into the holes.

Items Included in Box:

- Santa Fe Advance2 Dehumidifier
- Santa Fe Advance2 Installation & Operation Instructions
- Santa Fe Advance2 Leveling Feet
- 8' Drain Hose
- Drain Adapter

Important Precautions

- Do not install the Santa Fe Advance2 with the intake or exhaust of the unit within 1' of a wall or other obstruction. Avoid directing the discharge air at people. The dehumidifier should be used in the upright position.
- Do not place the unit where curtains or debris can be drawn into the intake and restrict airflow.
- The device is designed to be installed indoors in a space that is protected from rain and flooding.
- Do not operate in standing water or place the unit near open water. If used near a water source; be certain there is no chance the unit could fall into the water or get splashed and that it is plugged into a dedicated circuit and Ground Fault Circuit Interrupter (GFCI) protected outlet.
- Install the unit with enough space to access all sides for maintenance and service. The top "L" shaped panel needs to be removed in order to do repairs.
- DO NOT use the dehumidifier as a bench or table.
- DO NOT place the dehumidifier directly on structural building members without vibration absorbers or unwanted noise may result. Place the Santa Fe Advance2 on supports to raise the base of the unit.

Location Considerations

- Locate the dehumidifier near a suitable drain (8' drain hose included). Allow for proper drainage and routing of needed drain pipes.
- Locate the dehumidifier in an area where the cord's length (9') easily reaches a 115 VAC electrical outlet with a minimum of a 15 Amp circuit capacity.
- The unit is designed to operate while level. If the unit is placed on an unlevel surface, refer to section below (Installing Leveling Feet). Failure to level the unit may result in leakage or improper drainage.
- The unit should be suspended with a hang kit from the floor joists if there is any possibility of flooding. A flooded unit is not covered by warranty. DO NOT install the feet if you are using the hang kit. DO NOT hang the Santa Fe Advance2 from its' cabinet.

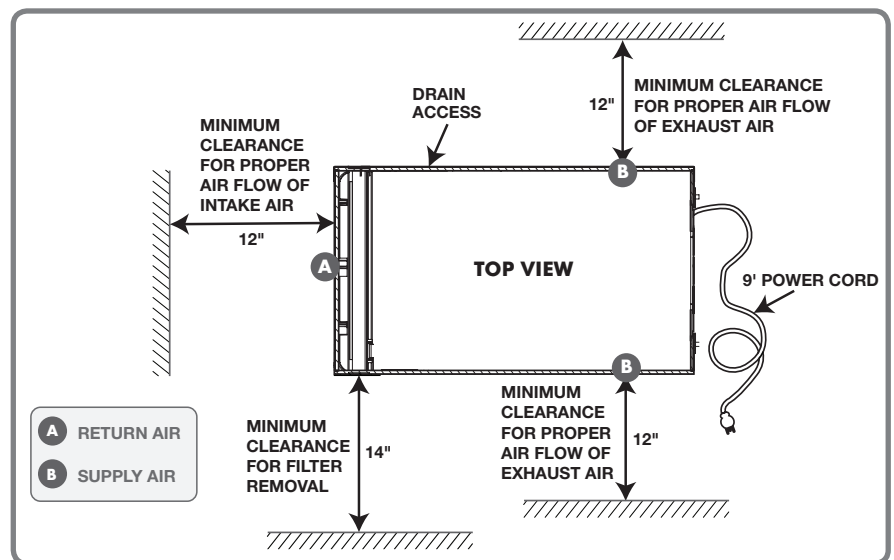

- Allow sufficient clearance to handle the unit's overall dimensions as well as any optional return and supply ductwork to the unit.
- Allow sufficient clearance for filter removal and to prevent airflow obstruction.
- Electrical service access will require the removal of the top "L" shaped panel. Allow sufficient clearance around the unit.

Installing Leveling Feet

- Lay down a protective pad (pillow, blanket, etc.).
- Carefully turn unit onto side.
- Install leveling feet and adjust to the desired position to ensure unit is level for proper drainage.
- Carefully bring unit to upright position.
- Wait a minimum of 10 minutes before operating.

Ducting To Finished Areas (Optional)

Attaching Duct Collars

Return Air Inlet

An 10" diameter duct collar and a front panel are attached to the unit.

Supply Air Outlet

Two 10" diameter duct collars attach to the outlets on each side of the unit. They can be attached to one exhaust outlet or both exhaust outlets. Use the included duct plate to block off one of the outlets if needed.

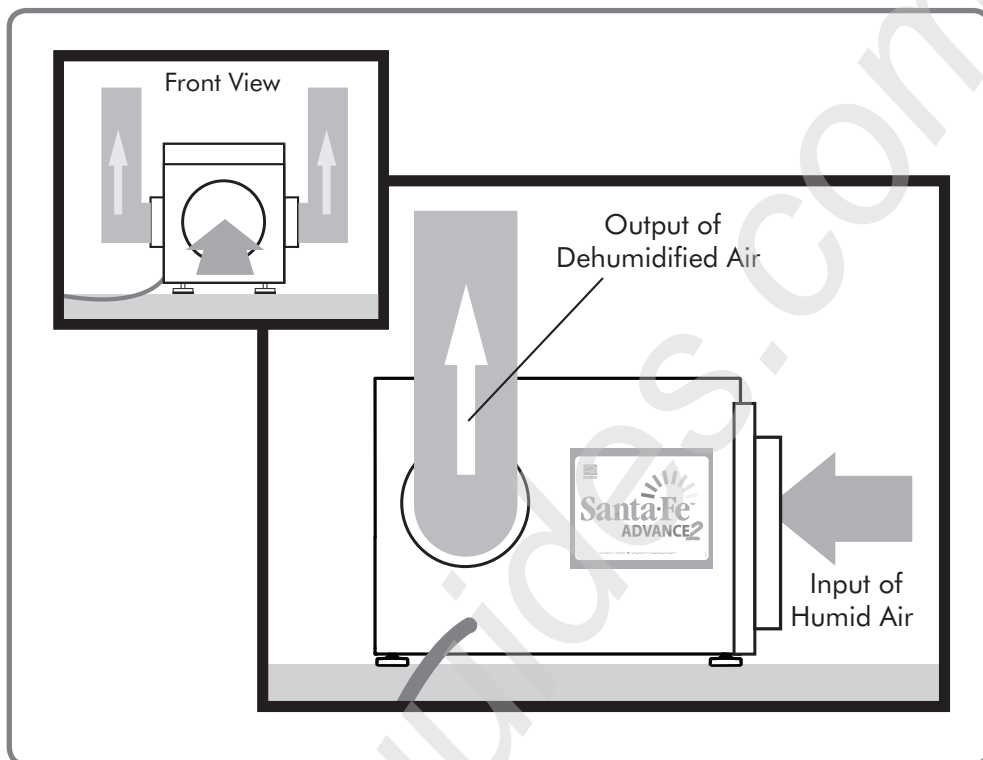

Ducting To Finished Areas (Optional)

Recommended Installations

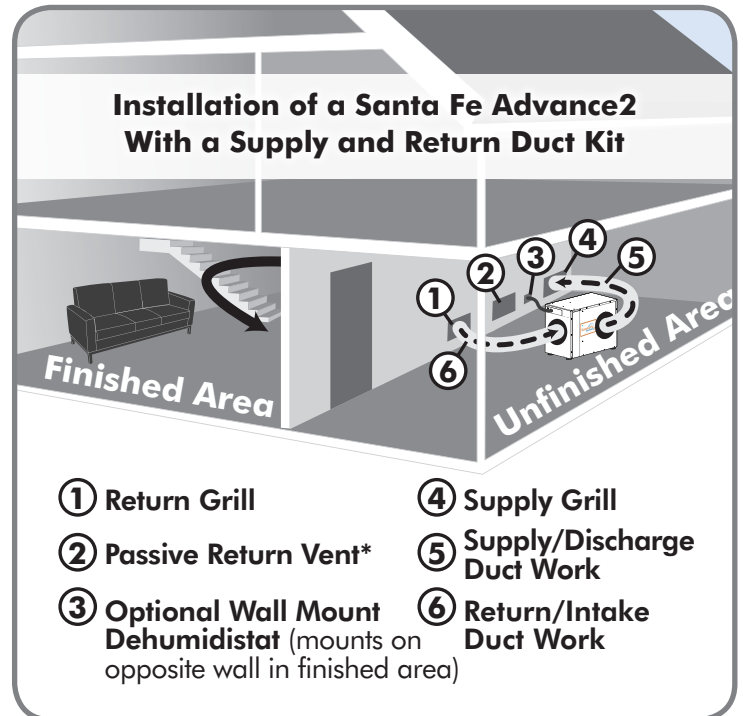
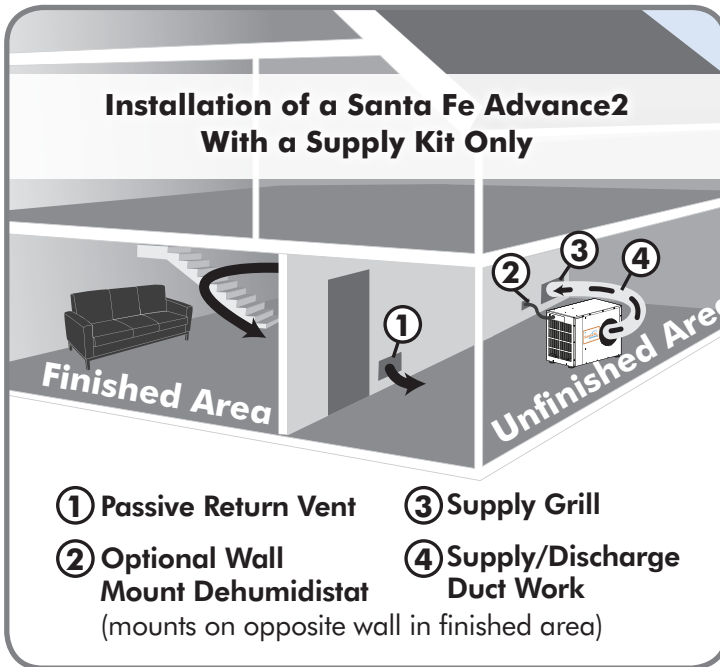

- Place the Santa Fe Advance2 in the unfinished area of the basement, near a drain access (condensate will drain via gravity or with an optional pump kit).
- Using the supply duct collar, supply the dry air from the dehumidifier into a large, open area in the finished section of the basement.
- Place a return grill / passive vent on the other side of the wall that separates the finished and unfinished areas. This will allow for a circular air flow throughout the basement.
- The passive grill will prevent the unfinished room from being placed under a negative pressure and also allow the dehumidifier to focus on keeping the unfinished area dry as well.
- The onboard dehumidistat control can be used on the unit for this application or a 120 volt dehumidistat can be placed in the finished basement as well (we recommend using an electrician to run the wiring).
- Be sure to keep all doors open to any other rooms in the basement to help with proper air circulation (bedrooms, bathrooms, etc.)

- Place the Santa Fe Advance2 in the unfinished area of the basement, near a drain access (condensate will drain via gravity or with an optional pump kit).
- Using the supply and return duct kit, supply the dry air from the dehumidifier into a large, open area of the finished basement. Use the return duct kit to draw air back through the dehumidifier.
- Be sure the return and supply are at least 10 feet away from each other for proper air flow throughout the basement. Add a passive grill between the finished and unfinished areas (*or have a 2" gap under the door separating the two rooms). This will help keep the unfinished area dry as well.
- Use the 120 volt, wall mounted dehumidistat for this installation for proper run time on the dehumidifier (we recommend using an electrician to install the separate 120 volt control).
- Be sure to keep all doors open to any other rooms in the basement to help with proper air circulation (bedrooms, bathrooms, etc.)

Drain Installation

The Santa Fe Advance2 generates condensate.

Place a secondary drain pan under the dehumidifier if it is suspended above a finished area or above an area where water leakage could cause damage.

A drain trap is required for the dehumidifier to run properly. Install a 3/4" threaded male NPT adapter to the drain or drain pan if one is being used. Install a drain pipe assembly utilizing 3/4" PVC pipe to transport the condensate to a drain. Pitch of drain should be 1" per 10'.

An optional condensate pump kit is available for use with the Santa Fe Advance2 and may be installed if lift is required to dispose of condensate. Condensate is automatically pumped to a remote location when the water level in the pump's reservoir rises to close the float switch.

The pump also contains a safety float switch. The white leads from this switch extend from beneath the pump cover. This switch should be installed in series with the field wire that connects to the common lead from the Santa Fe Advance2 to the control panel. If the pump fails, this switch opens the common control circuit and stops water production before the reservoir overflows. Contact a qualified electrician to install the safety float switch to the Santa Fe Advance2 dehumidifier.

Note: An optional condensate pump kit can be purchased from a local dealer or online.

The Santa Fe Advance2 requires a drain trap. Creating a drain trap allows a small amount of water to build up in the trap area of the clear hose. This prevents air from back flowing through the hose and into the dehumidifier; essentially causing the unit to backflow water out of the corners of the machine. Position the trap in the hose approximately 8"-10" from the dehumidifier and make sure the highest point of the trap is still at least 2" below the black drain port adapter on the dehumidifier. If the highest point of the trap is above the drain port, water will back flow into the dehumidifier. Check the hose regularly to ensure water is draining properly.



PVC materials available from your local hardware store.

For additional information on how to create a proper trap, see our instructional video at: www.Santa-Fe-Products.com/draintrap

Use care to keep the hose as flat to the floor as possible after your trap is in place. Be sure the hose is not kinked or otherwise restricted so water can pass through the hose freely. Improper installation of the drain hose may result in water leakage.

If the Santa Fe Advance2 is located too far from the floor drain and the provided hose does not reach, you may use a 1/2" PVC rigid pipe to extend the drain. Rigid PVC tubing is readily available from your local hardware store. Be sure the extension is at a down-ward slope to the drain.

An optional condensate pump kit may be installed if lift is required to remove condensate. To order, contact your local dealer or visit our website at www.santa-fe-products.com. You may also reach us by phone at (800) 533-7533.

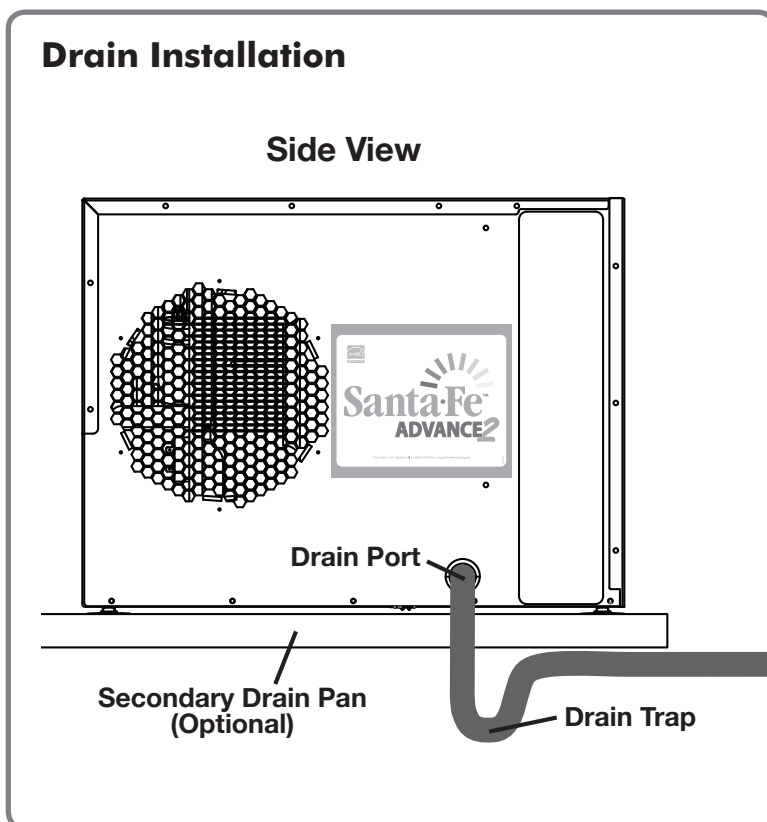

Operation

Humidity Control Adjustment

The humidity control is an adjustable switch that turns the dehumidifier on and off. It turns on when the relative humidity (RH) rises to the dial set point. It turns off when the RH is within $\pm 5\%$ of the set point.

Approximate Humidity Levels Per Setting

"Drier"	35% to 45% Relative Humidity
"Normal"	45% to 55% Relative Humidity (Recommended for most applications)
"Humid"	55% to 65% Relative Humidity

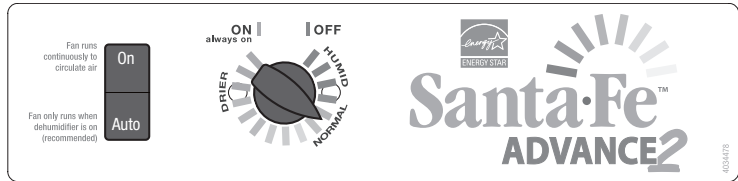

The dehumidifier will run continuously until the RH is reduced to the humidity control dial setting. It is not recommended to set the humidity control to "dry" in rooms under 65°; doing so will result in long periods of ineffective dehumidifier run time.

To turn unit on, turn the humidity dial clockwise to the recommended "NORMAL" position and set fan control to "FAN AUTO." To turn the unit off, turn the humidity dial counter clockwise to the "OFF" position and set fan control to "FAN AUTO."



The Acurite Hygrometer (part number 4029577) is available to accurately monitor humidity levels. Please contact your dealer or order online.

Defrost Cycle

This product includes a defrost thermostat. This feature prevents internal damage caused by excessive frost forming within the unit. When the unit is experiencing excessive frost the system will stop dehumidifying and the fan will run until normal operating conditions are present.

Fan Operation

Turning the fan switch "FAN ON" will cause the unit's internal blower to run continuously, whether the unit is dehumidifying or not. This function is desirable if the unit is used for air circulation or filtration. Turning the fan switch to "FAN AUTO" will cause the unit's internal blower to run only while the unit is dehumidifying.

Air Filtration

The Santa Fe Advance2 is equipped with MERV-8 air filter. An optional MERV-11 filter is available at www.Santa-Fe-Filters.com. The filters should be checked and replaced every three to six months. Operating the unit with a dirty filter will reduce dehumidifier capacity and efficiency.

DO NOT operate the unit without the standard MERV-8, or optional MERV-11 filter. Filter non-compliance voids the product warranty.

⚠ CAUTION!

MAKE SURE UNIT IS OFF BEFORE CHANGING THE FILTER. FAILURE TO FOLLOW FILTER HANDLING INSTRUCTIONS MAY RESULT IN IMPROPER FUNCTION OF THE DEHUMIDIFIER AND CAUSE PREMATURE FILTER WEAR OR UNIT DAMAGE.

Changing the Filter

For greatest filtration and efficiency of the Santa Fe Advance2, it is recommended the air filters be replaced every three to six months.

Step 1 - Remove the magnetized filter door by pulling it off of the dehumidifier. You can remove it on either side to gain access to the filter.

Step 2 - Remove the filter by pulling it out of the filter compartment.

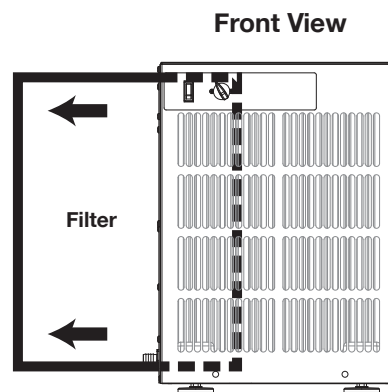
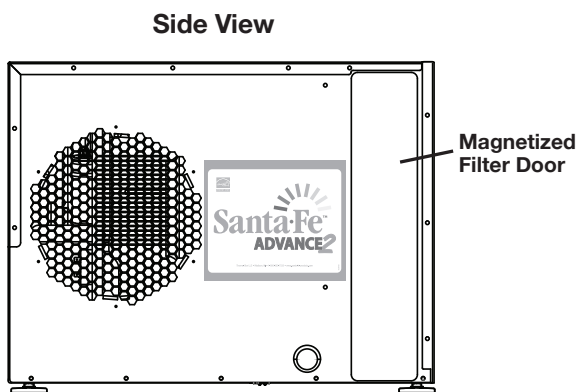

Step 3 - Insert the new filter into the filter compartment and attach the magnetized filter door back into place, ensuring it covers the filter compartment completely. Be sure the arrows on the filter are facing into the dehumidifier.

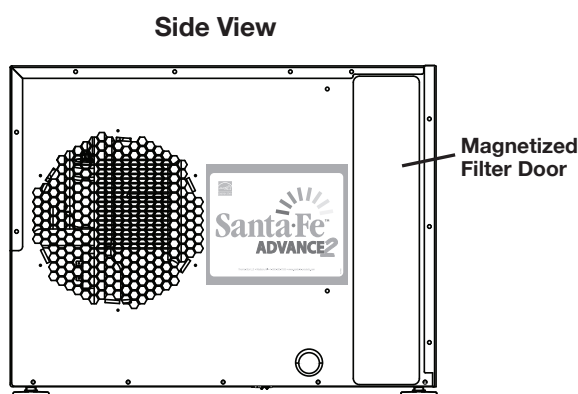
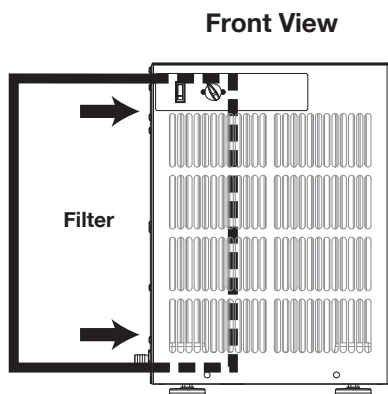

Air Filtration

MERV Rating Chart

Standard 52.5 Minimum Efficiency Reporting Value	Dust Spot Efficiency	Arrestance	Typical Controlled Contaminant	Typical Applications and Limitations	Typical Air Filter/Cleaner Type
20	n/a	n/a	< 0.30 pm particle size	Cleanrooms	>99.999% eff. On .10-.20 pm Particles
19	n/a	n/a	Virus (unattached)	Radioactive Materials	Particles
18	n/a	n/a	Carbon Dust	Pharmaceutical Man.	Particulates
17	n/a	n/a	All Combustion smoke	Carcinogenetic Materials	>99.97% eff. On .30 pm Particles
16	n/a	n/a	.30-1.0 pm Particle Size	General Surgery	Bag Filter - Nonsupported
15	>95%	n/a	All Bacteria	Hospital Inpatient Care	microfine fiberglass or synthetic media, 12-36 in. deep, 6-12 pockets.
14	90-95%	>98%	Most Tobacco Smoke	Smoking Lounges	Box Filter - Rigid Style Cartridge Filters 6 to 12" deep may use lofted or paper media.
13	89-90%	>98%	Proplet Nuceli (Sneeze)	Superior Commercial Buildings	lofted or paper media.
12	70-75%	>95%	1.0-3.0 pm Particle Size Legionella	Superior Residential	Bag Filter - Nonsupported microfine fiberglass or synthetic media, 12-36 in. deep, 6-12 pockets.
11	60-65%	>95%	Humidifier Dust Lead Dust	Better Commercial Buildings	Box Filter - Rigid Style Cartridge Filters 6 to 12" deep may use lofted or paper media.
10	50-55%	>95%	Milled Flour Auto Emissions	Hospital Laboratories	
9	40-45%	>90%	Welding Fumes		
8	30-35%	>90%	3.0-10.0 pm Particle Size	Commercial Buildings	Pleated Filters - Disposable, extended surface area, thick with cotton-polyester blend media, cardboard frame.
7	25-30%	>90%	Mold Spores Hair Spray	Better Residential	Cartridge Filters - Graded density viscous coated cube or pocket filters, synthetic media.
6	<20%	85-90%	Fabric Protector Dusting Aids	Industrial Workplace	Throwaway - Disposable synthetic panel filter.
5	<20%	80-85%	Cement Dust Pudding Mix	Paint Booth Inlet	
4	<20%	75-80%	>10.0 pm Particle Size Pollen	Minimal Filtration	Throwaway - Disposable fiberglass or synthetic panel filter.
3	<20%	70-75%	Dust Mites Sanding Dust	Residential	Washable - Aluminum Mesh.
2	<20%	65-70%	Spray Paint Dust		Electrostatic - Self charging woven panel filter.
1	<20%	<65%	Textile Fibers Carpet Fibers	Window A/C Units	

http://www.mechreps.com/PDF/Merv_Rating_Chart.pdf

Electrical Requirements

The Santa Fe Advance2 plugs into a common grounded 115VAC outlet. The device draws 5.7 Amps at 80°F and 60% RH. Locate the dehumidifier in an area where the cord's length (9') easily reaches a 115 VAC electrical outlet with a minimum of 15 Amp circuit capacity. If used in an area that may become wet, a GFCI protected circuit is recommended. The unit should not be used in areas prone to flooding. Consult local electrical codes for any further information.

An optional remote dehumidistat is available for use with the Santa Fe Advance2 and is to be located remotely from the dehumidifier.

CAUTION!

ELECTRICAL SHOCK HAZARD: Electrical power must be present to perform some tests. These tests should be performed by a qualified service person.

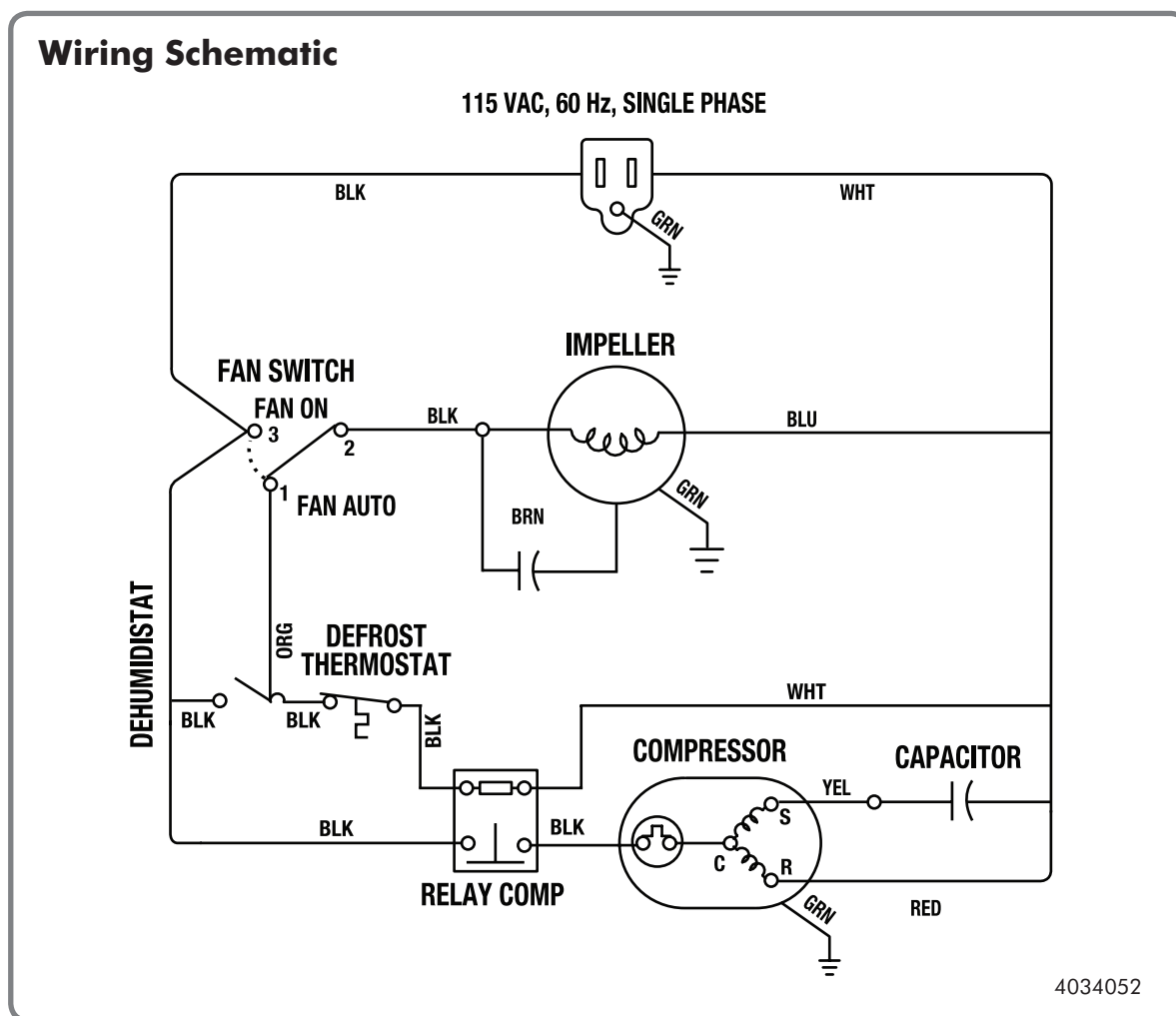

Service

WARNING!

SERVICING THE SANTA FE ADVANCE2, WITH ITS HIGH PRESSURE REFRIGERANT SYSTEM AND HIGH VOLTAGE CIRCUITRY PRESENTS A HEALTH HAZARD WHICH COULD RESULT IN DEATH, SERIOUS BODILY INJURY, AND/OR PROPERTY DAMAGE. ONLY QUALIFIED SERVICE PEOPLE SHOULD SERVICE THIS UNIT.

Replacement Parts

4034887-02	Evaporator
4036164-08	Capillary Tubes
4034888	Compressor
1970010	Compressor Relay
4029510	Filter/drier
4035868	Condensor
4032196	Impeller
4033032-03	35mfd 370V Capacitor - Compressor
4035235-02	5mfd 370V Capacitor - Impeller
4026221	Leveling Foot
4031376	Defrost Thermostat
4027172	Humidity Controller
4025560	Fan Switch

Refrigerant Charging

If the refrigerant charge is lost due to service or a leak, a new charge must be accurately weighed in. If any of the old charge is left in the system, it must be recovered before weighing in the new charge. Refer to the unit nameplate for the correct charge weight and refrigerant type.

Compressor/Capacitor Replacement

This compressor is equipped with a two terminal external overload and a run capacitor, but no start capacitor or relay.

Troubleshooting

CAUTION!

TROUBLESHOOTING SHOULD BE PERFORMED BY A QUALIFIED HVAC TECHNICIAN.

Symptom	Possible Reason
Neither fan nor compressor running. Dehumidification is being called for.	<ol style="list-style-type: none"> 1. Dehumidifier unplugged or no power to outlet. 2. Humidity control set too high. 3. Loose connection in internal or control wiring. 4. Defective compressor relay.
Compressor is not running. Dehumidification is being called for. Fan is running.	<ol style="list-style-type: none"> 1. Defective compressor run capacitor. 2. Loose connection in compressor circuit. 3. Defective compressor overload. 4. Defective compressor. 5. Defrost thermostat open.
Compressor cycles on and off. Dehumidification is being called for.	<ol style="list-style-type: none"> 1. Low ambient temperature and/or humidity causing unit to cycle through defrost mode. 2. Defective compressor overload. 3. Defective compressor. 4. Defrost thermostat defective. 5. Dirty air filter(s) or air flow restricted. 6. Defective fan or relay.

Service - Troubleshooting

CAUTION!

TROUBLESHOOTING SHOULD BE PERFORMED BY A QUALIFIED HVAC TECHNICIAN.

Symptom	Possible Reason	Troubleshooting Procedure
Fan is not running. Dehumidification or fan is being called for.	<ol style="list-style-type: none"> 1. Loose connection in fan circuit. 2. Obstruction prevents fan impeller rotation. 3. Defective fan. 4. Defective fan relay. 	<p> WARNING!</p> <p>ELECTRICAL SHOCK HAZARD: ELECTRICAL POWER MUST BE PRESENT TO PERFORM SOME TESTS. THESE TESTS SHOULD BE PERFORMED BY A QUALIFIED SERVICE PERSON.</p>
Low dehumidification capacity (evaporator is frosted continuously). Dehumidification is being called for.	<ol style="list-style-type: none"> 1. Defrost thermostat loose or defective. 2. Low refrigerant charge. 3. Dirty air filter(s) or air flow restricted. 4. Excessively restrictive ducting connected to unit. 	<p>Troubleshooting Procedure for Performance Related Issues</p> <p>This method of diagnosis is used to function check the internal components in the dehumidifier. This is to be used when a performance issue is suspected.</p> <ol style="list-style-type: none"> 1. Set the humidity controller all the way to the most humid setting or off position – Did the unit shut off? 2. If yes, turn the fan setting to the ON position – does the fan start? 3. If fan starts, leave in the fan ON position and set the humidity all the way to driest setting. May have to wait 5 minutes for the compressor to start. 4. Listen for a distinct buzzing/humming sound of a compressor starting up – do you hear this noise? 5. If compressor is running and continues to run, after about 15 minutes you should feel a slight increase in air temperature being discharged out of the discharge air side of the unit. 6. If so, depending on your environmental conditions (temp/Rh%), you should see some water production out of the hose within 30 minutes or so. (<i>Note: If the room temperature is 55 degrees or below and/or in area of low relative humidity, the dehumidifier will produce little to no water.</i>) 7. Collecting the water removed in a 24 hour period will give a measurement of performance.
Dehumidifier removes some water, but not as much as expected.	<ol style="list-style-type: none"> 1. Air temperature and/or humidity have dropped. 2. Humidity meter and or thermometer used are out of calibration. 3. Unit has entered defrost cycle. 4. Dirty air filter(s) or air flow is restricted. 5. Defective defrost thermostat. 6. Low refrigerant charge. 7. Air leak such as loose cover or ducting leaks. 8. Defective compressor. 9. Restrictive ducting. 	

Warranty

Limited Warranty. Therma-Stor, LLC (“Therma-Stor”) warrants as follows: (i) the Santa Fe Advance2 dehumidifier (“Product”) will be free of material defects in workmanship or materials for a period of 2 years (“Two-Year Warranty”) following the date of initial purchase of such Product by an original customer purchasing from Therma-Stor or an authorized reseller (“Customer”); and (ii) the Product’s condenser, evaporator, and compressor will be free of material defects in workmanship or materials for a period of five (5) years following the date of initial purchase of such Product by a Customer.

Limitation of Remedies. CUSTOMER’S SOLE AND EXCLUSIVE REMEDY UNDER THE ABOVE LIMITED WARRANTY AND THERMA-STOR’S ENTIRE LIABILITY THEREUNDER, SHALL BE, AT THE SOLE OPTION OF THERMA-STOR, REPLACEMENT OR REPAIR OF SUCH PRODUCT OR ITS COMPONENTS (“COMPONENTS”) BY THERMA-STOR OR THERMA-STOR’S AGENTS ONLY. REFRIGERANT, PIPING, SUPPLIES, TRANSPORTATION COSTS, LABOR COSTS INCURRED IN REPAIR OR REPLACEMENT OF SUCH COMPONENTS ARE NOT INCLUDED. THIS DISCLAIMER AND EXCLUSION SHALL APPLY EVEN IF THE EXPRESS WARRANTY AND LIMITED REMEDY SET FORTH HEREIN FAILS OF ITS ESSENTIAL PURPOSE. CUSTOMER ACKNOWLEDGES THAT NO REPRESENTATIVE OF THERMA-STOR OR OF ITS AFFILIATES OR RESELLERS IS AUTHORIZED TO MAKE ANY REPRESENTATION OR WARRANTY ON BEHALF OF THERMA-STOR OR ANY OF ITS AFFILIATES OR RESELLERS THAT IS NOT IN THIS AGREEMENT. Notwithstanding the above, during the term of the Two-Year Warranty only, Therma-Stor will provide, free of charge to Customer, all Components and labor (except costs related to removal and installation of Product) required to fulfill its obligations under such Two-Year Warranty.

Disclaimer of Warranties. EXCEPT FOR ABOVE LIMITED WARRANTY, WHICH IS THE SOLE AND EXCLUSIVE WARRANTY PROVIDED WITH RESPECT TO THE PRODUCT AND ITS COMPONENTS, THERMA-STOR HEREBY DISCLAIMS ALL EXPRESS AND IMPLIED WARRANTIES, INCLUDING, WITHOUT LIMITATION, THE IMPLIED WARRANTIES OF MERCHANTABILITY AND FITNESS FOR A PARTICULAR PURPOSE.

Warranty Limitations. The foregoing limited warranty extends only to a Customer and shall be null and void upon attempted assignment or transfer. A “defect” under the terms of the limited warranty shall not include problems resulting from Customer’s or Customer’s employees’, agents’, invitees’ or a third party’s misuse, improper installation, improper design of any system in which the Product is included, abuse, lack of normal care, failure to follow written instructions, tampering, improper repair, or freezing, corrosion, acts of nature or other causes not arising out of defects in Therma-Stor’s workmanship or material. If a Product or Component is replaced while under warranty, the applicable limited warranty period shall not be extended beyond the original warranty time period. The limited warranty does not cover any costs related to changes to a Product or Component that may be required by any codes, laws, or regulations that may become effective after initial purchase of the Product by Customer.

Customer Responsibilities. As a further condition to obtaining warranty coverage hereunder, the Customer must send a valid warranty claim to Therma-Stor such that Therma-Stor receives such claim prior to the end of the applicable warranty period. Therma-Stor shall have no obligation hereunder with respect to any claim received by Therma-Stor after the expiration of the applicable warranty period. As a further condition to obtaining warranty coverage hereunder, the Customer must present forms of invoices evidencing proof of purchase of a Product. If such invoices do not clearly indicate the date of initial purchase by a Customer, the applicable Product’s date of manufacture will be used instead of the date of initial purchase for the purpose of calculating the commencement of the applicable warranty period. Warranty service must be performed by Therma-Stor or a servicer authorized by Therma-Stor. In order to obtain warranty service, the Customer should call Therma-Stor at 1-800-533-7533 and ask for the Therma-Stor Products Service Department, which will then arrange for applicable warranty service. Warranty service will be performed during customary, daytime working hours. If the Product must be shipped for service, Customer shall be solely responsible for properly packaging the Product, for all freight charges, and for all risk of loss associated with shipment.

Limitation of Liability. IN NO EVENT SHALL THERMA-STOR, IN CONNECTION WITH THE DESIGN, SALE, INSTALLATION, USE, REPAIR, REPLACEMENT OR PERFORMANCE OF ANY PRODUCT, COMPONENT, PART THEREOF OR WRITTEN MATERIAL PROVIDED THEREWITH, BE LIABLE, TO THE EXTENT ALLOWED UNDER APPLICABLE LAW, UNDER ANY LEGAL THEORY FOR ANY SPECIAL, DIRECT, INDIRECT, COLLATERAL OR CONSEQUENTIAL DAMAGES OF ANY KIND. NOTWITHSTANDING THE ABOVE LIMITATIONS AND WARRANTIES, THE SOLE AND EXCLUSIVE LIABILITY OF THERMA-STOR, REGARDLESS OF THE NATURE OR THEORY OF THE CLAIM, SHALL UNDER NO CIRCUMSTANCES EXCEED THE PURCHASE PRICE OF THE PRODUCT, COMPONENT OR PART UPON WHICH THE CLAIM IS PREMISED.

Applicable Law and Venue. ANY ARBITRATION, ENFORCEMENT OF AN ARBITRATION OR LITIGATION RELATED TO THE PRODUCT WILL BE BROUGHT EXCLUSIVELY IN DANE COUNTY, WISCONSIN, AND CUSTOMER CONSENTS TO THE JURISDICTION OF THE FEDERAL AND STATE COURTS LOCATED THEREIN, SUBMITS TO THE JURISDICTION THEREOF AND WAIVES THE RIGHT TO CHANGE VENUE. CUSTOMER FURTHER CONSENTS TO THE EXERCISE OF PERSONAL JURISDICTION BY ANY SUCH COURT WITH RESPECT TO ANY SUCH PROCEEDING.

Miscellaneous. If any term or condition of this Limited Warranty is found by a court of competent jurisdiction to be invalid, illegal or otherwise unenforceable, the same shall not affect the other terms or conditions hereof or thereof or the whole of this Limited Warranty. Any delay or failure by Therma-Stor to exercise any right or remedy will not constitute a waiver of Therma-Stor to thereafter enforce such rights.

all-guides.com



www.Santa-Fe-Products.com
1.800.533.7533