

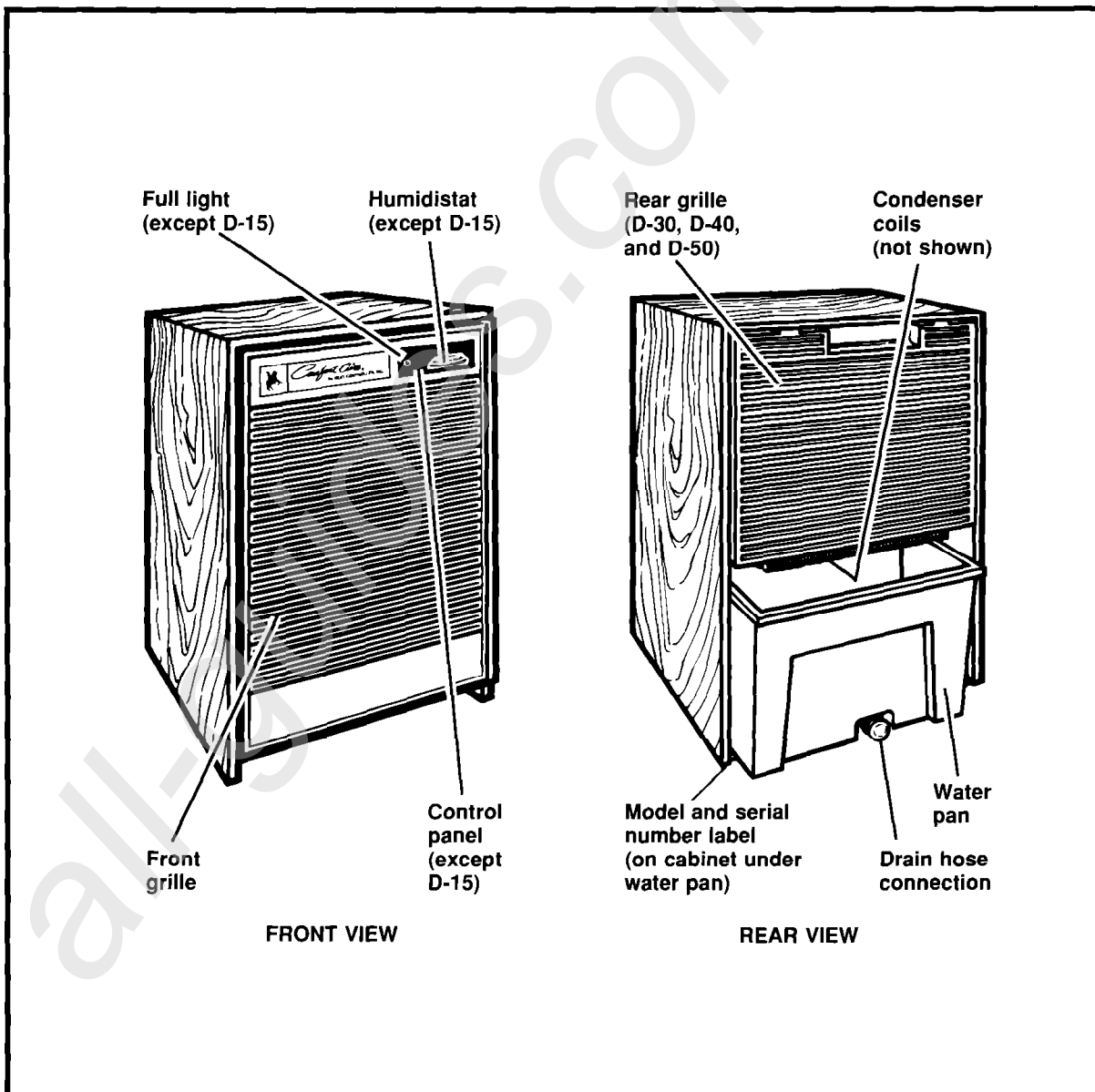

DEHUMIDIFIER

Use & Care Guide



Contents

	Page
Important Safety Instructions	2
Before Using Your Dehumidifier	3
Install properly	3
Electrical requirements	4
Using Your Dehumidifier	5
Model D-15	6
Models D-20, D-30, D-40 and D-50	6
Water disposal methods	8
Caring For Your Dehumidifier	9
If You Need Service Or Assistance	12

Thank you for buying a Comfort-Aire® dehumidifier. Please complete and mail the Ownership Registration Card provided with this product. Then complete the form below. Have this information ready if you need service or call with a question.

- Copy model and serial numbers from label (see diagram on front cover) and purchase date from sales slip.
- Keep this book and sales slip together in a handy place.

Model Number

Serial Number

Purchase Date

Service Company Phone Number

Important Safety Instructions

⚠ WARNING

To reduce the risk of fire, electrical shock or personal injury when using your dehumidifier, follow these basic precautions:

- Read all instructions before using your dehumidifier.
- Complete the installation and electrical requirements as described in "Before Using Your Dehumidifier" on pages 3 and 4.
- Never allow children to operate or play with the dehumidifier.
- Never clean dehumidifier parts with flammable fluids. The fumes can create a fire hazard or explosion.

• FOR YOUR SAFETY •

DO NOT STORE OR USE GASOLINE OR OTHER FLAMMABLE VAPORS AND LIQUIDS IN THE VICINITY OF THIS OR ANY OTHER APPLIANCE. THE FUMES CAN CREATE A FIRE HAZARD OR EXPLOSION.

It is your responsibility to be sure your dehumidifier:

- Has been properly installed on a floor, table or shelf that is reasonably level and strong enough to support unit with a full pan of water. Unit can weigh between 50 and 75 lbs. (depending on the amount of water collected in the pan).
- Is the correct size for the area you want to dehumidify.
- Is connected to the proper kind of outlet, with the correct electrical supply and grounding. (See "Electrical requirements" on page 4)
- Is used only for jobs expected of home dehumidifiers.
- Is not used by children or anyone unable to operate it properly.
- Is properly maintained.
- Is used in an area where the room temperature will not fall below 65°F (18.3°C).

- SAVE THESE INSTRUCTIONS -

DO NOT REMOVE TECH SHEET from inside cabinet. Your service technician will need this information.

Before Using Your Dehumidifier

Install properly

⚠ WARNING

Personal Injury Hazard

Because your dehumidifier weighs between 50 and 75 lbs. (depending on the amount of water collected in the pan), it is recommended that you use proper lifting techniques when lifting or moving your unit. Failure to do so could result in personal injury.

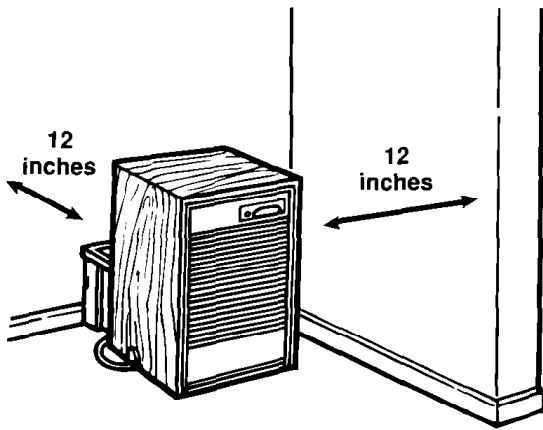

1. Allow at least 12 inches (30.5 cm) of space on all sides of the unit for good air circulation.

2. Install the unit on a floor, table or shelf. When installing the unit on a table or shelf, be sure it is strong enough to support the unit with a full pan of water. A table or shelf may be a better position from which to handle the water pan. Do not sit or stand on this product. The height of a table or shelf may help prevent icing of coils due to colder air near the floor (such as can be found in a basement).
3. Keep all outside doors, windows and other openings closed when dehumidifier is operating. Humid outdoor air will add to the dehumidifier's operating load.
4. **The water pan must be properly positioned**, on the hangers inside the cabinet, when dehumidifier is operating in order for the automatic shut-off to operate correctly.
5. On most models, two rollers let you easily move the dehumidifier. Remove the water pan. Tilt unit forward and roll to another position.

If your model does not have rollers, pick up the unit to move it to another position.

**Before Using Your Dehumidifier
Continued**

Electrical requirements

OBSERVE ALL GOVERNING CODES AND ORDINANCES.

Electrical ground is required on this appliance.

A 115 volt, 60 Hz., AC only, 15 ampere fused electrical supply is recommended. (Time delay fuse or circuit breaker is recommended.) It is recommended that a separate circuit serving only this appliance be provided. **Do not use an extension cord.**

DO NOT, UNDER ANY CIRCUMSTANCES, REMOVE THE POWER SUPPLY CORD GROUND PRONG.

Recommended grounding method

For your personal safety, this appliance must be grounded. This appliance is equipped with a power supply cord having a 3-prong grounding plug. To minimize possible shock hazard, the cord must be plugged into a mating grounding type wall receptacle, grounded in accordance with the National Electrical Code and local codes and ordinances. If a mating wall receptacle is not available, it is the responsibility of the customer to have a properly grounded, 3-prong wall receptacle installed by a qualified electrician.

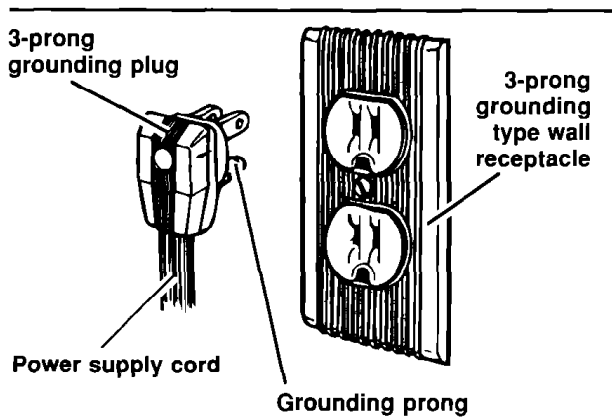

Using Your Dehumidifier

You will use your dehumidifier more during months when you're not heating your home. However, your dehumidifier can help prevent excessive moisture and keep you comfortable all year long, in any area of your home.

- Use in a basement to help prevent moisture damage.

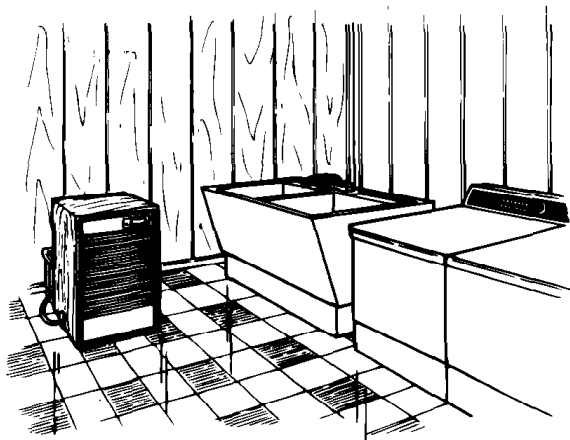

- Use in cooking, laundry, bathing and dishwashing areas which have excess moisture.

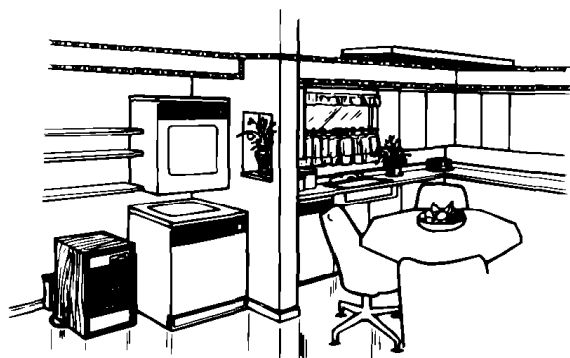

- Use to prevent moisture damage anywhere books or valuables are stored.

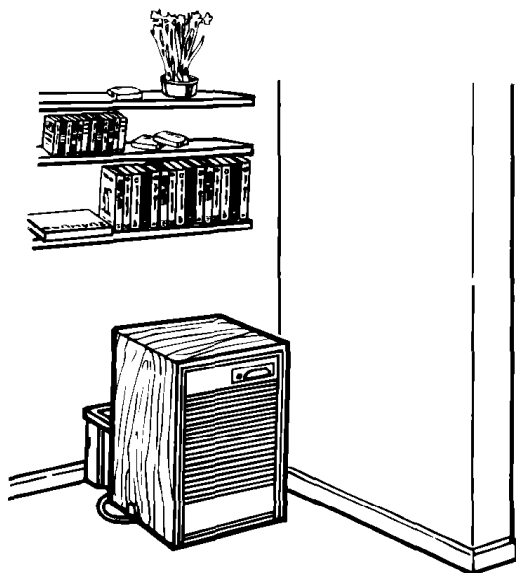

**Using Your Dehumidifier
Continued**

Model D-15

This model does not have an On/Off Switch or a Humidistat.

- **To turn unit on** – plug power supply cord into electrical outlet. Be sure to use the correct grounding technique. (See page 4.)
- **To turn unit off** – unplug power supply cord from electrical outlet.

NOTE: This model does not have a Water Level Control Switch. To prevent overflow, the water pan should be checked often and emptied when it is 1/2 to 3/4 full, unless another water disposal method is being used. (See “Water disposal methods” on page 8.)

CAUTION

Do not operate dehumidifier at temperatures below 65°F (18.3°C). The coils may become iced over and unit will not operate properly.

Models D-20, D-30, D-40 and D-50

Control panel

These units have a control panel containing two controls – the Full Light and the Humidistat.

Full Light – This light glows when the water pan is full and needs to be emptied.

Humidistat – This controls the amount of moisture left in the room. When the humidity in the room increases, the unit automatically starts. When the humidity decreases to the selected level, the unit automatically stops. The unit will run constantly when control is set to DRYEST.

Unit operation

1. Turn Humidistat to UNIT OFF. Plug power supply cord into electrical outlet. Be sure to use the correct grounding technique. (See page 4.)



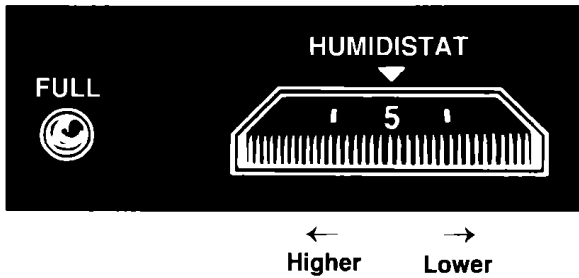

2. Turn Humidistat left toward DRYEST for normal operation. Set at 5 or 6 to start. Adjust later, if necessary.

If you need more dehumidification, turn Humidistat left to a higher number. If you need less, turn Humidistat right to a lower number.

3. Stop the unit manually by turning Humidistat right to UNIT OFF.

Frost control (D-20, D-30, D-40 and D-50)

CAUTION

Do not operate dehumidifier at temperatures below 65°F (18.3°C). The coils may become iced over and unit will not operate properly.

Your Comfort-Aire® dehumidifier is equipped with a feature to help you get the most comfort from your new appliance by permitting it to operate down to 65°F (18.3°C). If your dehumidifier runs when room temperature and humidity conditions are low, frost can form on its evaporator coil. This interferes with proper operation.

The Frost Control senses frost build-up on the evaporator coil and automatically shuts off the compressor. The fan continues to run, drawing air across the coil and melting the frost. When the coil is defrosted, the compressor is automatically restarted, and dehumidifying is resumed.

Setting the water level adjustment

The Water Level Adjustment can be set in two positions to turn off the unit automatically when the pan is full. This prevents the danger of overflow.

Pan must be in proper position for Water Level Control Switch to work.

- **NORMAL FILL**— set Water Level Adjustment to the indentation on the left side. The water pan and water will weigh approximately 16 lbs. (7.2 kg) and water pan will be 1/2 full.
- **MAXIMUM FILL** — set Water Level Adjustment to the raised area on the right side. The water pan and water will weigh approximately 24 lbs. (10.8 kg) and water pan will be 3/4 full.

The Water Level Control Switch will automatically turn off the dehumidifier at the fill level you selected when pan is properly placed. Loosen the screw to move the Water Level Adjustment. Retighten screw when adjusted to desired setting.

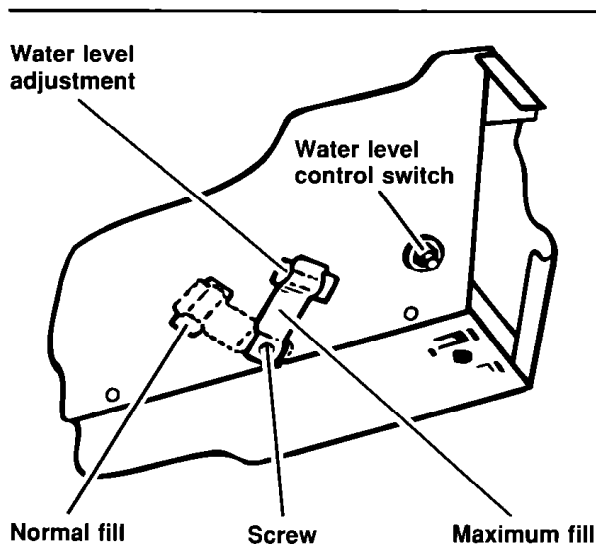

Using Your Dehumidifier Continued

Water disposal methods

⚠ WARNING

Personal Injury Hazard

Do not use the water that collects in the water pan for drinking purposes. It is not sanitary and could cause illness.

There are three methods of disposing of water.

1. Empty pan manually.

When pan is full, remove it, empty it into a large sink or tub, and put it back in place. **Be sure pan is properly placed so the Water Level Control Switch will work to shut off the unit automatically.**

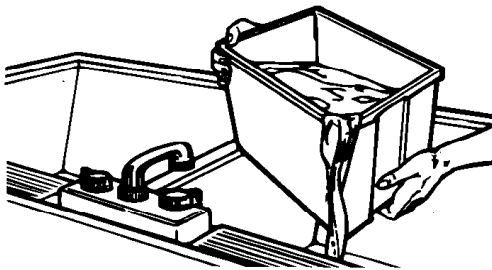

2. Place unit directly over drain.

Pan has a threaded hose connection which can be left open. Cut out opening with a knife or 3/4" wood drill. Once opened, hose connection will continually drain water from the pan. Be sure to keep unit directly over a drain.

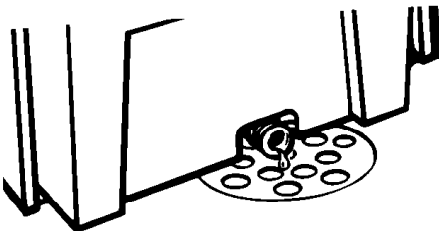

3. Attach garden hose to the threaded hose connection to carry water to drain.

- Pan has a threaded hose connection which can be left open. Cut out opening with a knife or 3/4" wood drill.
- Attach garden hose. Be sure hose does not kink or bend. It should lie flat from unit to drain.
- Once hose connection is opened, pan will continually drain through the hose. Be sure to keep hose flat and in drain.

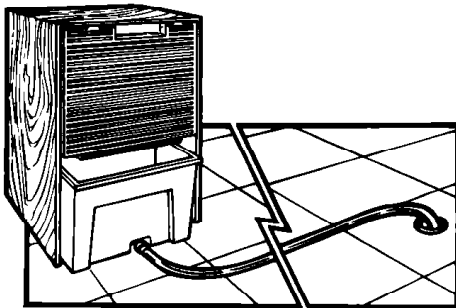

Caring For Your Dehumidifier

Your dehumidifier is designed to serve you year-round. It needs practically no attention. However, you should check your dehumidifier and inspect the coils annually.

You may call a service company to perform this annual checkup or you can do it yourself. Cost of annual inspection is the owner's responsibility.

OR

If you are familiar with electrical appliances, you can do this inspection and maintenance yourself. If you choose to do so, follow these steps:

⚠ WARNING

Electrical Shock and Personal Injury Hazard

- **Disconnect power supply cord from receptacle before performing any maintenance. Failure to do so could result in electrical shock.**
- **Be careful when cleaning the coils. Fins are sharp. Failure to do so could result in personal injury.**

1. Disconnect power supply cord.
2. To remove outer cabinet:
 - Take off the plastic front grille. Remove the two screws at the bottom. Drop grille down and take out.
 - Remove the socket head screws on each side of cabinet.

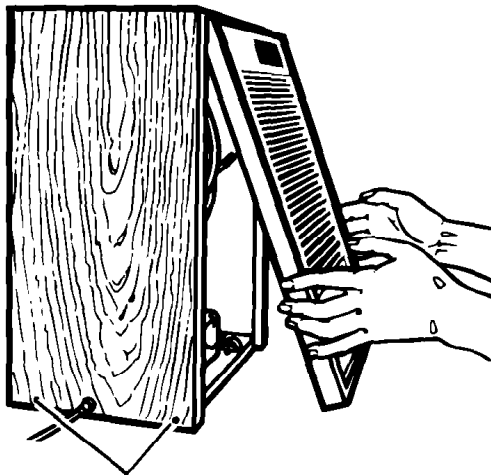

Socket head screws
(on sides of cabinet)

Caring For Your Dehumidifier Continued

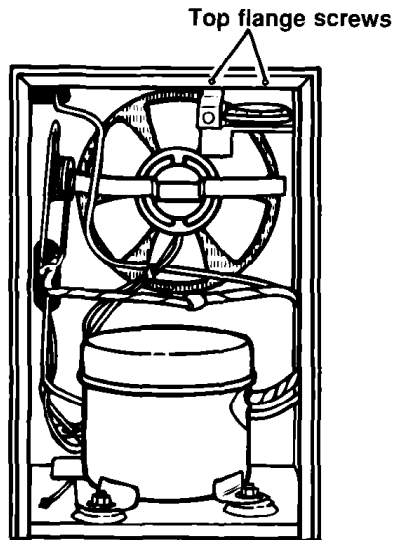

- Remove the top flange screws.

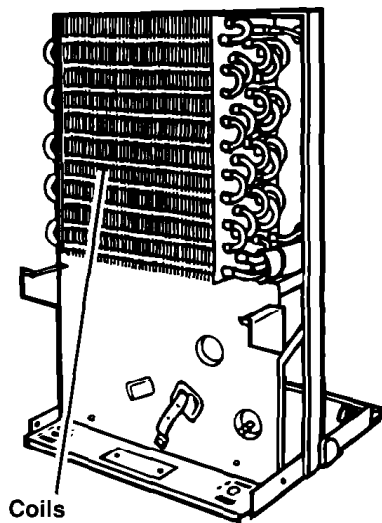

- **For models D-30, D-40 and D-50:** Remove the rear grille. Pull out at bottom and drop grille down.
 - Lift cabinet from base.
3. Coils should be inspected annually. Brush clean, if necessary, with warm water and mild detergent. Rinse and dry thoroughly. **Be sure power supply cord is disconnected from receptacle.**
4. The compressor is sealed and needs no oiling. **The fan motor is prelubricated and does not require further oiling under normal operating conditions.** However, if the dehumidifier is operated under severe environmental conditions (dust, dirt, high temperatures) the fan motor should be oiled annually. Follow the instructions in step 5.

Fan
motor
oil
tubes

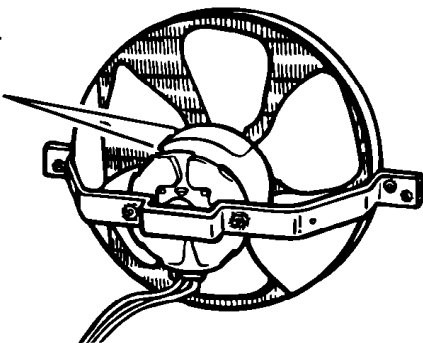

5. Oil the motor through the tubes provided. Use SAE #20 grade oil.

6. Wash plastic parts with a soft cloth, warm water and mild detergent. Rinse and dry with a soft cloth.

7. Replace cabinet and grilles.

8. Reconnect power supply cord.

all-guides.com

If You Need Service Or Assistance

Before you call for service...

If you are having an operating problem, check the chart to see what the cause might be before you call for assistance.

PROBLEM	CHECK IF	WHAT TO DO
Unit won't run.	<ul style="list-style-type: none"> • Power cord is plugged into a live circuit with proper voltage. • Fuse has blown or circuit breaker has tripped. Also check if a time-delay fuse has been used. 	<ul style="list-style-type: none"> • Firmly plug power cord into electrical outlet. Check circuit voltage at fuse/circuit breaker box. • Replace fuse with a time-delay fuse of the correct capacity. Reset circuit breaker.
Unit blows fuses or trips circuit breaker.	<ul style="list-style-type: none"> • Time-delay fuse being used is of correct capacity. • An extension cord is being used. • Coils are iced over or clogged with lint. 	<ul style="list-style-type: none"> • Replace fuse with a time-delay fuse of the correct capacity. • Do not use an extension cord with this or any other appliance. • See "Unit ices over" section in this chart, or clean lint from coils (see pages 9-11 for instructions).
Unit ices over.	<ul style="list-style-type: none"> • Humidity is too low. • Room temperature is too cool. 	<ul style="list-style-type: none"> • Do not operate unit when humidity is low. • Do not operate unit in temperatures below 65°F (18.3°C). Damage to the unit could occur.
Water collects on floor.	<ul style="list-style-type: none"> • Unit is level. • Hose is kinked or drain is clogged. • Water pan is overflowing. 	<ul style="list-style-type: none"> • Level unit front-to-back and side-to-side. • Remove clog from drain or unkink hose. • Remove and empty water pan. Be sure to replace pan properly and check to see that the unit is level.

Special dehumidifier needs

- Annual Inspection
Clean coils, inspect drain and hoses. If necessary, oil the fan motor (see pages 9-11).
- Moving
When moving, keep the unit in an upright position.

If you need service...

Call your dealer or the service company recommended by your dealer.



Heat Controller, Inc.
P.O. Box 1089
Jackson, MI 49204

® Registered Trademark of Heat Controller, Inc.